

# ONKYO SERVICE MANUAL

## STEREO CASSETTE TAPE DECK MODEL TA-RW255

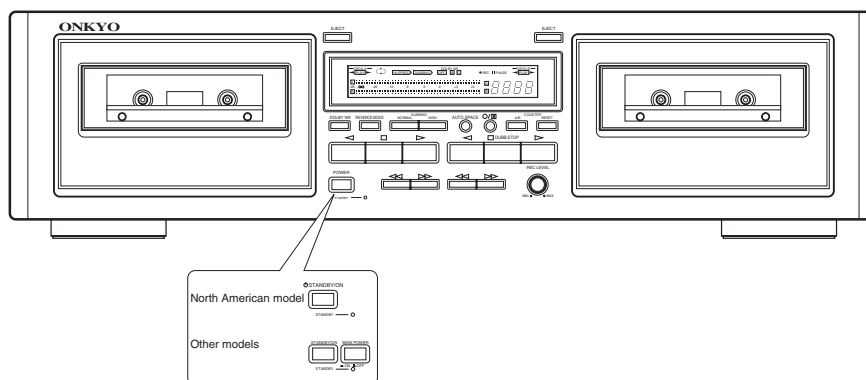

### Black and Silver models

BMDD	120V AC, 60Hz
BMPA, BMGT BMPP, SMPP	230-240V AC, 50Hz

### SAFETY-RELATED COMPONENT WARNING!!

COMPONENTS IDENTIFIED BY MARK  ON THE SCHEMATIC DIAGRAM AND IN THE PARTS LIST ARE CRITICAL FOR RISK OF FIRE AND ELECTRIC SHOCK. REPLACE THESE COMPONENTS WITH ONKYO PARTS WHOSE PART NUMBERS APPEAR AS SHOWN IN THIS MANUAL.

MAKE LEAKAGE-CURRENT OR RESISTANCE MEASUREMENTS TO DETERMINE THAT EXPOSED PARTS ARE ACCEPTABLY INSULATED FROM THE SUPPLY CIRCUIT BEFORE RETURNING THE APPLIANCE TO THE CUSTOMER.

## SPECIFICATIONS

<b>Format:</b>	Auto reverse double deck
<b>Track format:</b>	4-tracks, 2-channels
<b>Recording system:</b>	AC bias
<b>Erasing system:</b>	AC erase
<b>Tape speed:</b>	4.76 cm/sec. (1-7/8 i.p.s)
<b>Wow and Futter:</b>	0.13 % (WRMS)
<b>Frequency response:</b>	
Metal position tape	30 Hz to 15 kHz $\pm$ 3 dB
High position tape	30 Hz to 14 kHz $\pm$ 3 dB
Normal position tape	30 Hz to 13 kHz $\pm$ 3 dB
<b>Signal to noise ratio:</b>	56 dB (metal position tape/ Type IV, Dolby NR off)
	55 dB (high position/ Type II, Dolby NR off)
	50 dB (normal position/ Type I, Dolby NR off)
	Noise reduction of 10 dB above 5 kHz and 5 dB at 1 kHz possible with Dolby B.
	Noise reduction of 20 dB at 5 kHz possible with Dolby C.
<b>Input Jacks:</b>	
LINE IN:	2
Input sensitivity:	80 mV
Input impedance:	50 k ohm
<b>Output Jacks:</b>	
LINE OUT:	2
Standard output level:	500 mV
Output load impedance:	over 50 k ohm
<b>Motors:</b>	DC servo motor: 1+1
<b>Heads:</b>	
PB Head:	Special Hard Permalloy x 1
Rec/PB Head:	Special Hard Permalloy x 1
Erase head:	Ferrite x 1
<b>Power supply rating:</b>	North American: AC 120 V, 60 Hz European: AC 230 - 240 V, 50 Hz
<b>Power consumption:</b>	17 W
<b>Standby power consumption:</b>	
	North American: 7.0 W
	European: 0.6 W
<b>Dimensions: (W x H x D):</b>	
	435 mm x 121 mm x 303 mm (17-1/8" x 4-3/4" x 11-15/16")
<b>Weight:</b>	4.9 kg (10.8 lbs.)
<b>Operation condition temperature/humidity:</b>	
	5°C - 35°C/ 5% - 85% (no condensation)

Specifications and external appearance are subject to change without notice because of product improvements.



**EXPLODED VIEW**

**CASSETTE MECHANISM**  
**Z001 : CMAL2Z226B (PLAY Deck)**  
**Z002 : CMAL2Z227B (REC/PLAY Deck)**

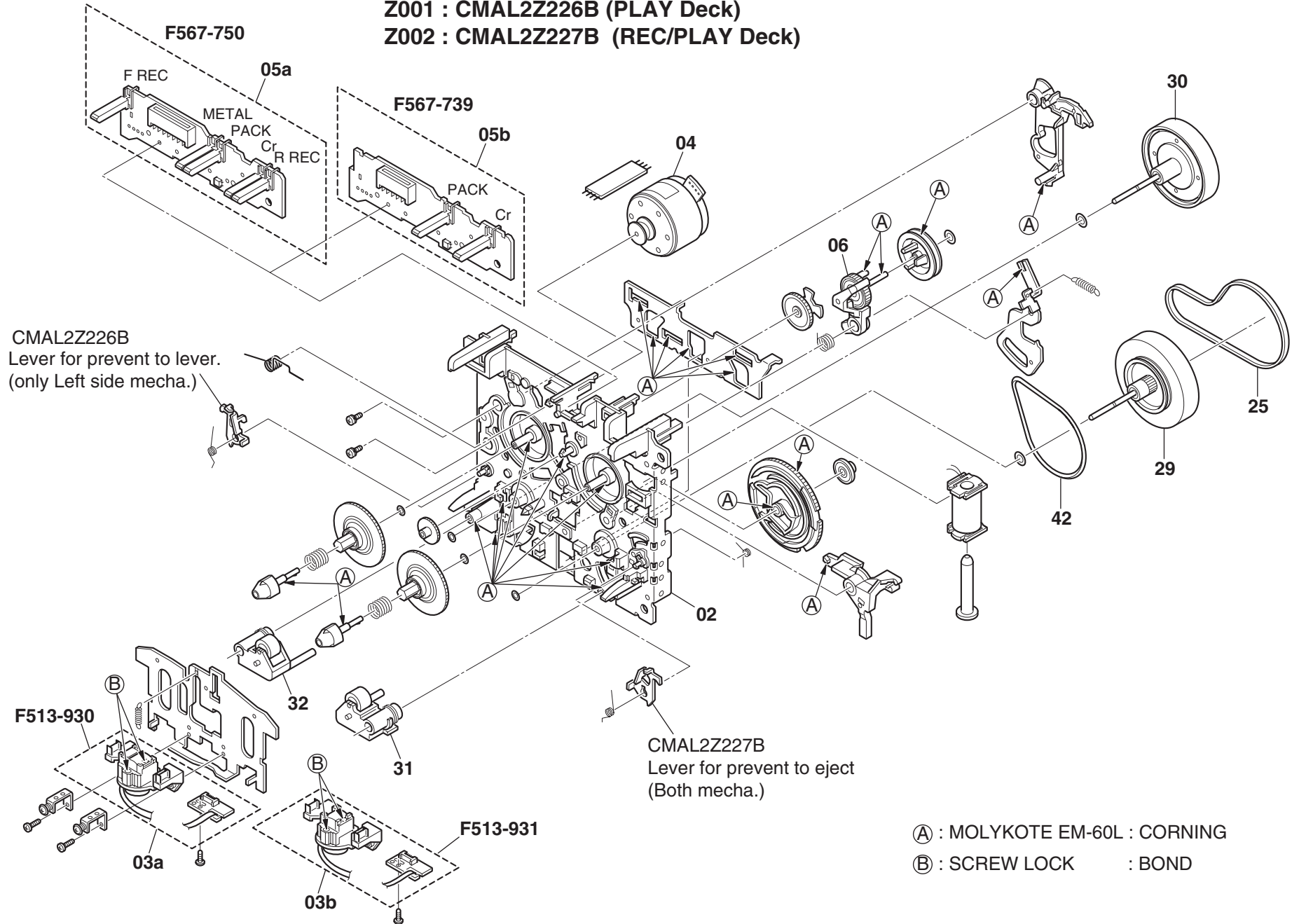

## CASSETTE MECHA. PARTS LIST

No.	PART No.	PART NAME	NOTE
03a	F513-931	PLATE HEADD BLOCK	226B
03b	F513-930	PLATE HEADD BLOCK	227B
04	F525-382	MOTOR MAIN BLOCK	
05a	F567-739	PCB CONTROL BLOCK	226B
05b	F567-750	PCB CONTROL BLOCK	227B
06	F522-063	CLUTCH ASSY BLOCK	
25	FF19N	MAIN BELT	
29	FR26D-11	ASSY F/W	F/W Material: ES-5
30	FR26B-21	ASSY F/W	F/W Material: ES-5 x 2
31	F514-133	ROLLER PINCH BLOCK R	
32	F514-134	ROLLER PINCH BLOCK L	
42	FF19S	F/R BELT	







SCHEMATIC DIAGRAM <MDD> ONLY

U01 MAIN PC BOARD NAAF-8555

U02 DISPLAY CIRCUIT PC BOARD NADIS-8556

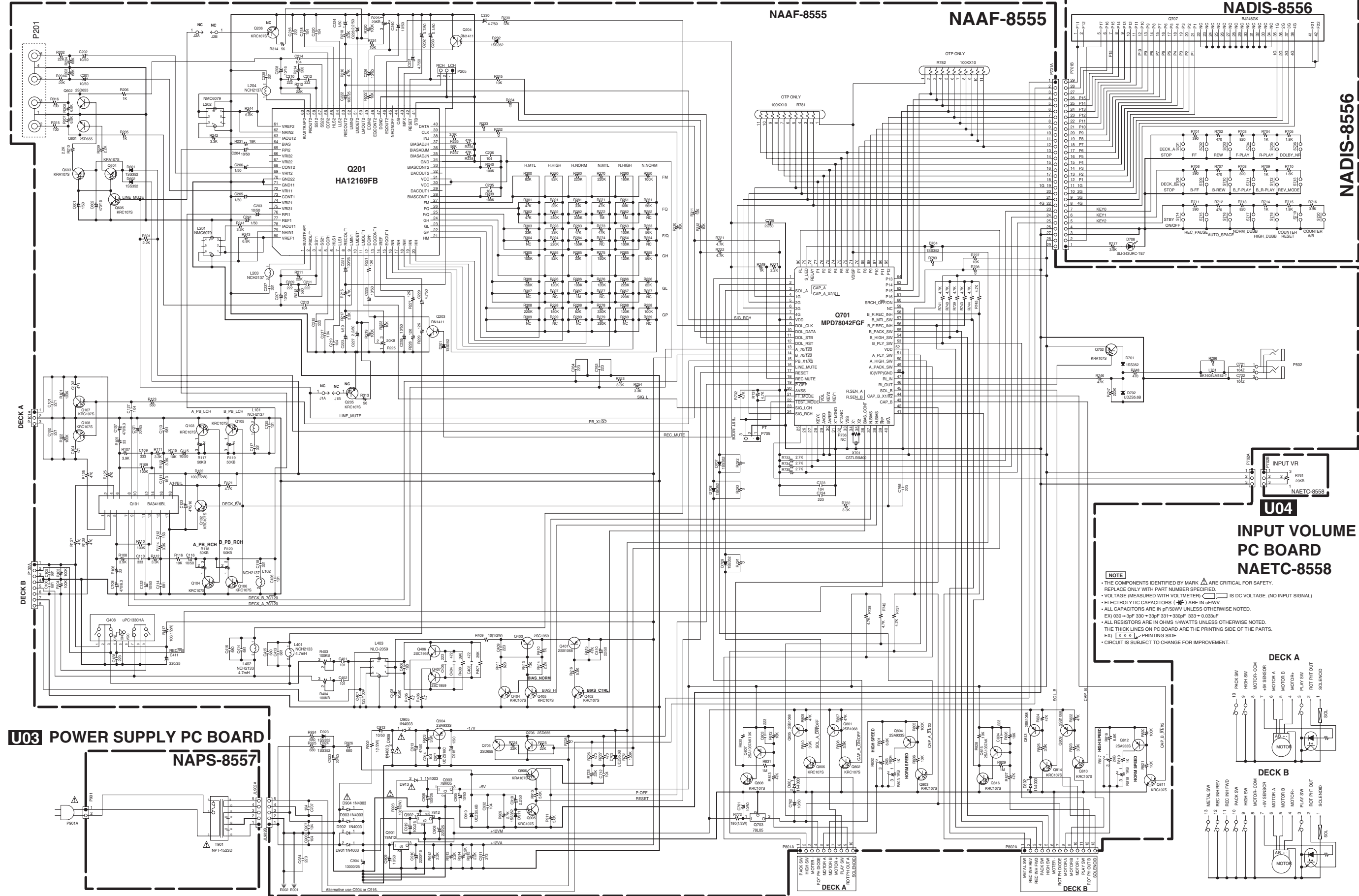

1

2

3

4

5

U04 INPUT VOLUME PC BOARD NAETC-8558

- NOTE**
- THE COMPONENTS IDENTIFIED BY MARK  $\Delta$  ARE CRITICAL FOR SAFETY. REPLACE ONLY WITH PART NUMBER SPECIFIED.
  - VOLTAGE (MEASURED WITH VOLTMETER) IS DC VOLTAGE. (NO INPUT SIGNAL)
  - ELECTROLYTIC CAPACITORS ( $\text{E}$ ) ARE IN  $\mu\text{F}$ .
  - ALL CAPACITORS ARE IN pF UNLESS OTHERWISE NOTED. EX) 030 = 3pF 330 = 33pF 331 = 330pF 333 = 0.033 $\mu\text{F}$
  - ALL RESISTORS ARE IN OHMS 1/4WATTS UNLESS OTHERWISE NOTED.
  - THE THICK LINES ON PC BOARD ARE THE PRINTING SIDE OF THE PARTS. EX)  $\text{X}$  (PRINTING SIDE)
  - CIRCUIT IS SUBJECT TO CHANGE FOR IMPROVEMENT.

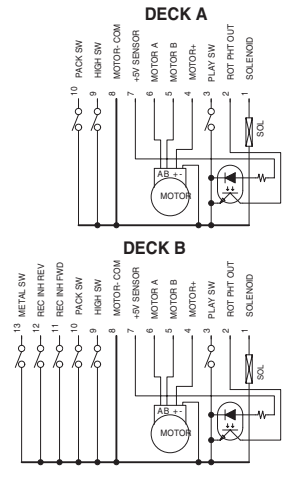



A B C D

# SCHEMATIC DIAGRAM

U01 MA

EXCEPT  
<MDD>

1

2

3

4

5

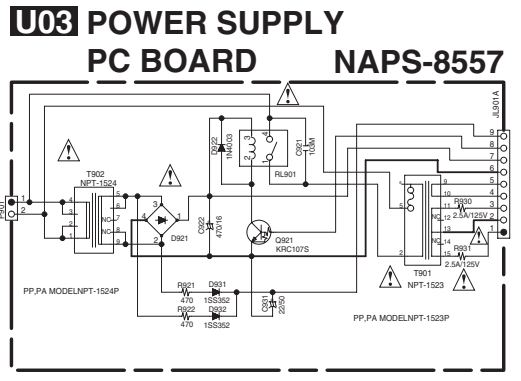
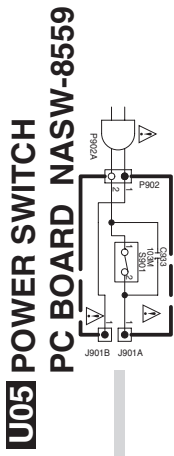
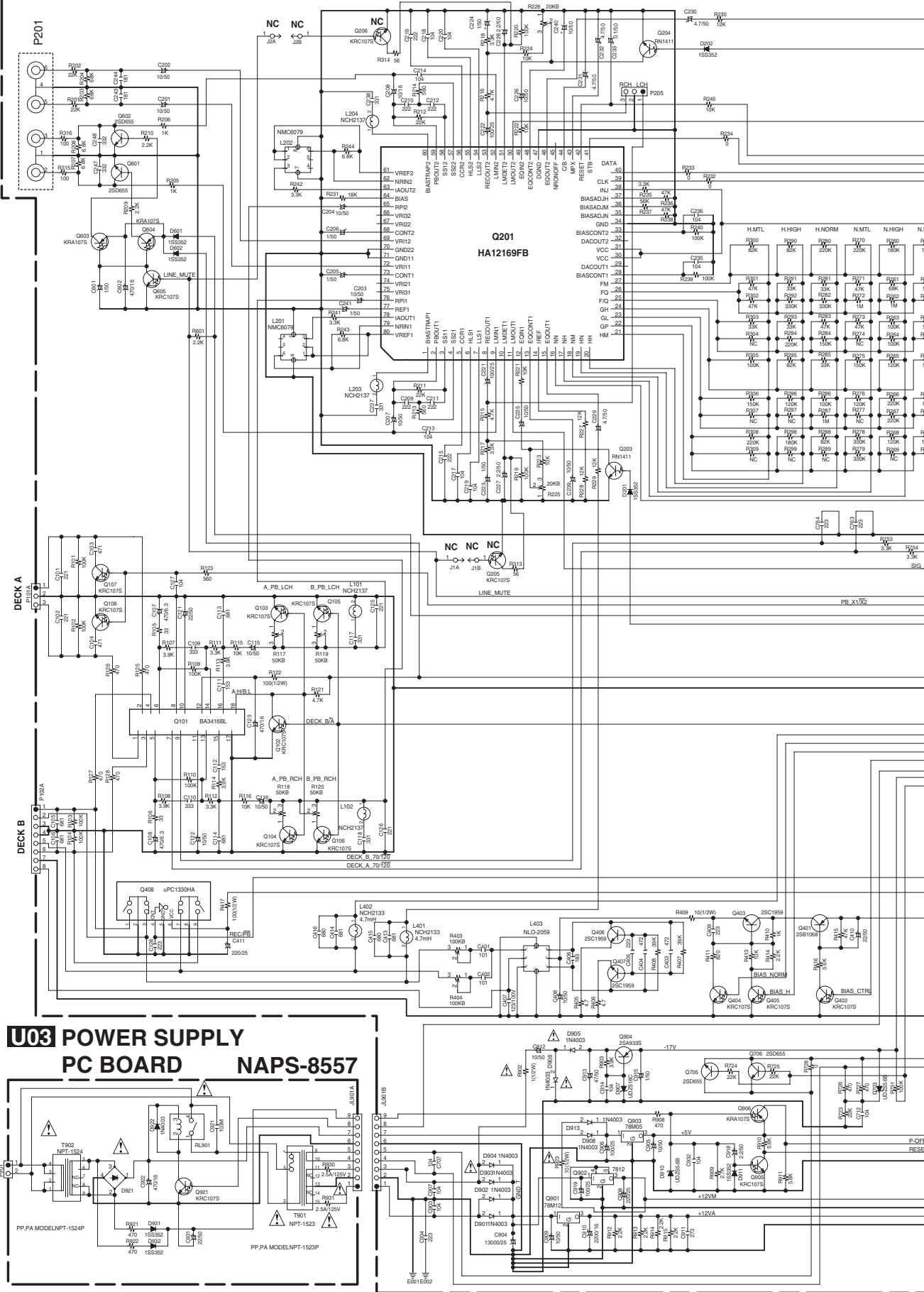



A B C D E F G H  
SCHEMATIC DIAGRAM U01 MAIN PC BOARD NAAF-8555 U02 DISPLAY CIRCUIT PC BOARD

EXCEPT <MDD>

1

2

3

4

5

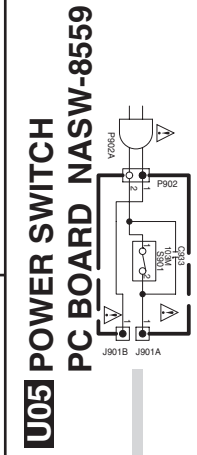
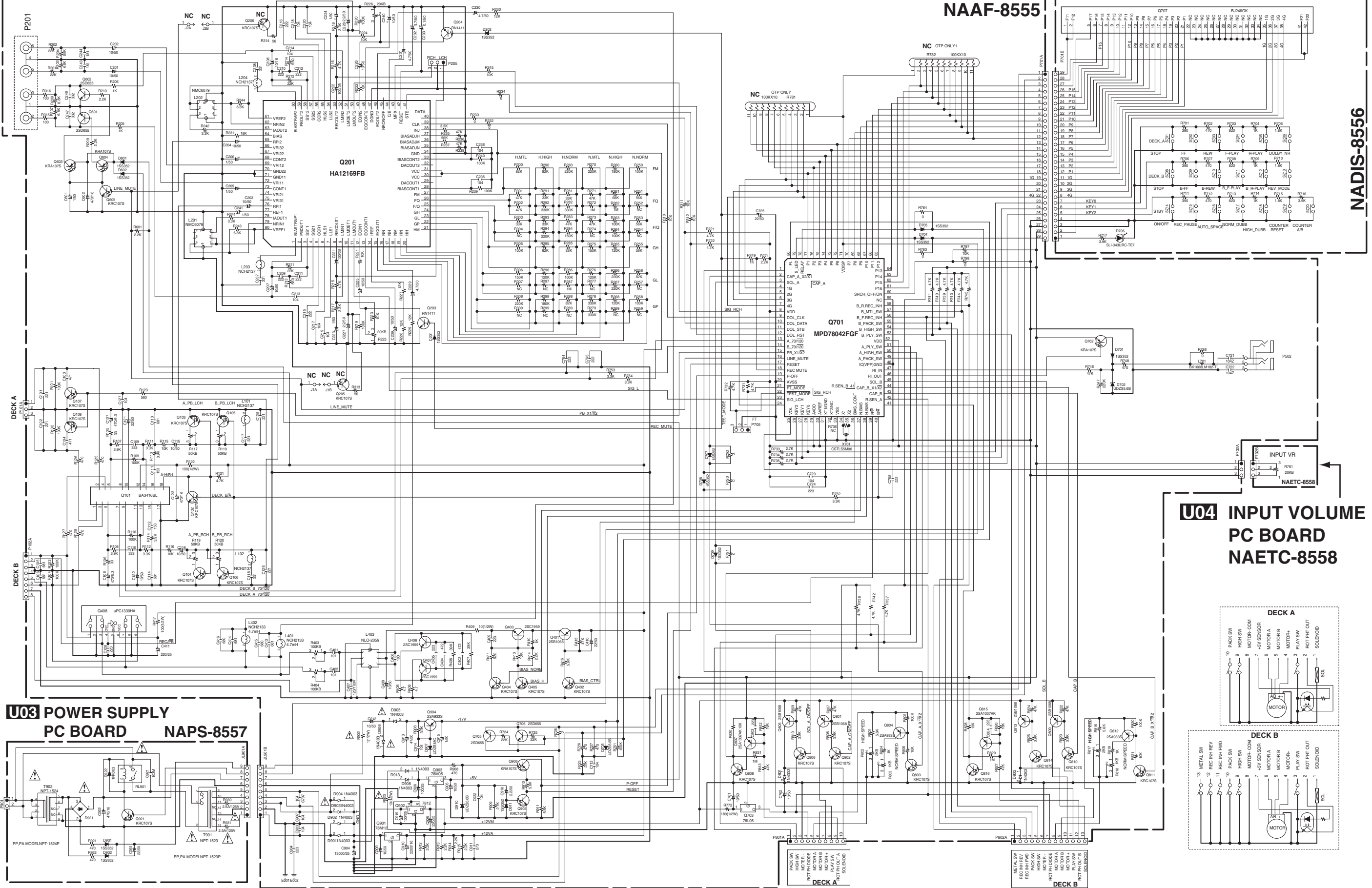

U04 INPUT VOLUME PC BOARD NAETC-8558

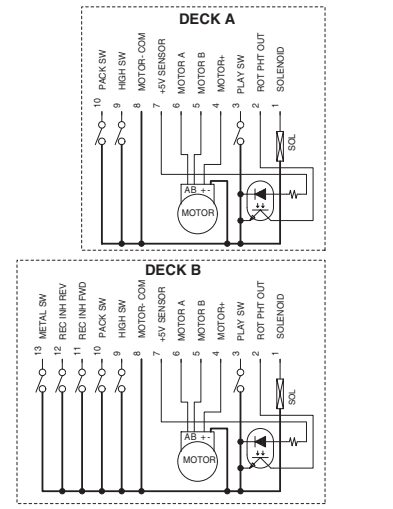

NADIS-8556

# PC BOARD CONNECTION DIAGRAM

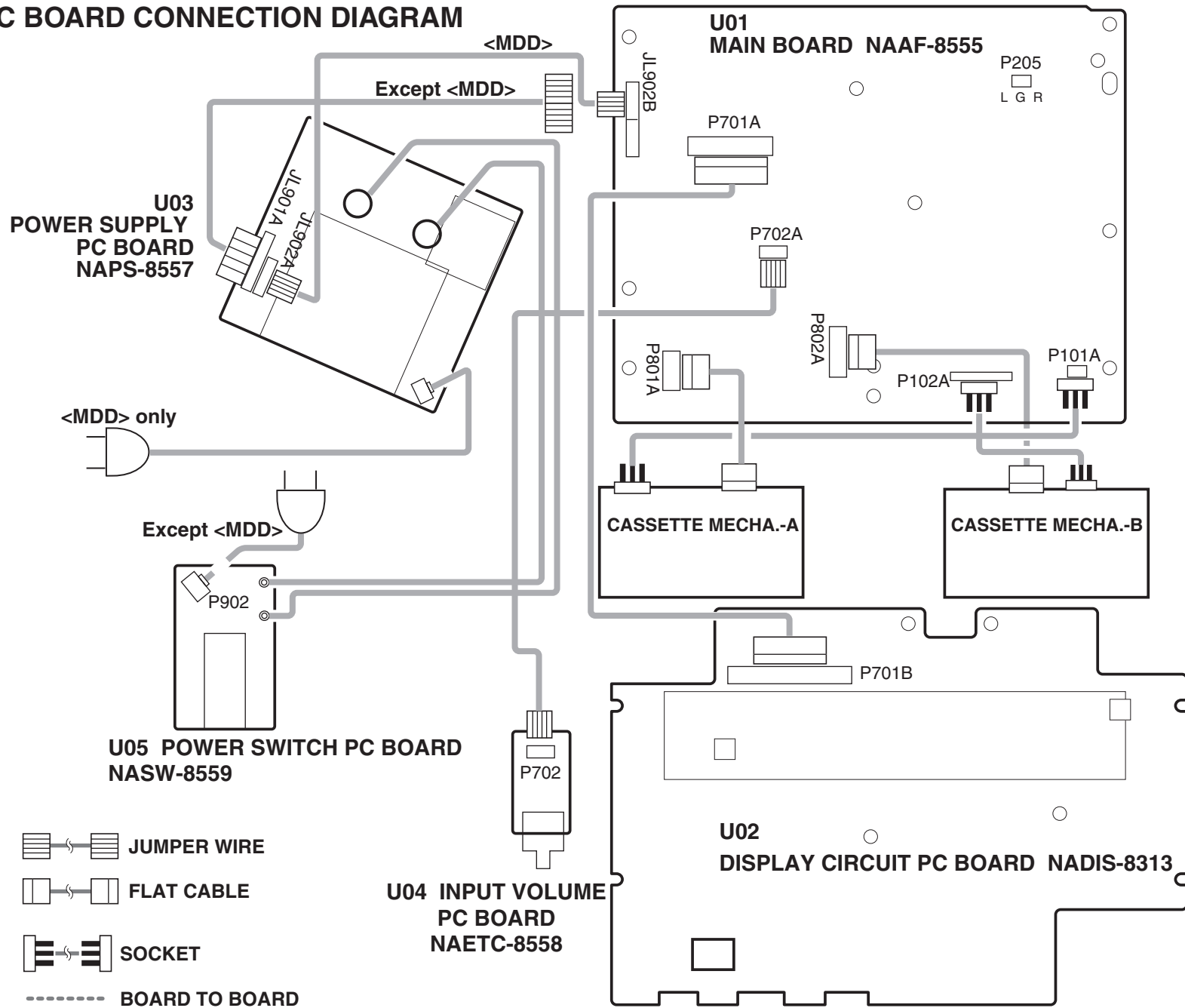

A

B

C

D

# PRINTED CIRCUIT BOARD VIEWS-1

**U01** MAIN PC BOARD  
 (NAAF-8555)  
 Component side view  
 from soldering side

1

2

3

4

5

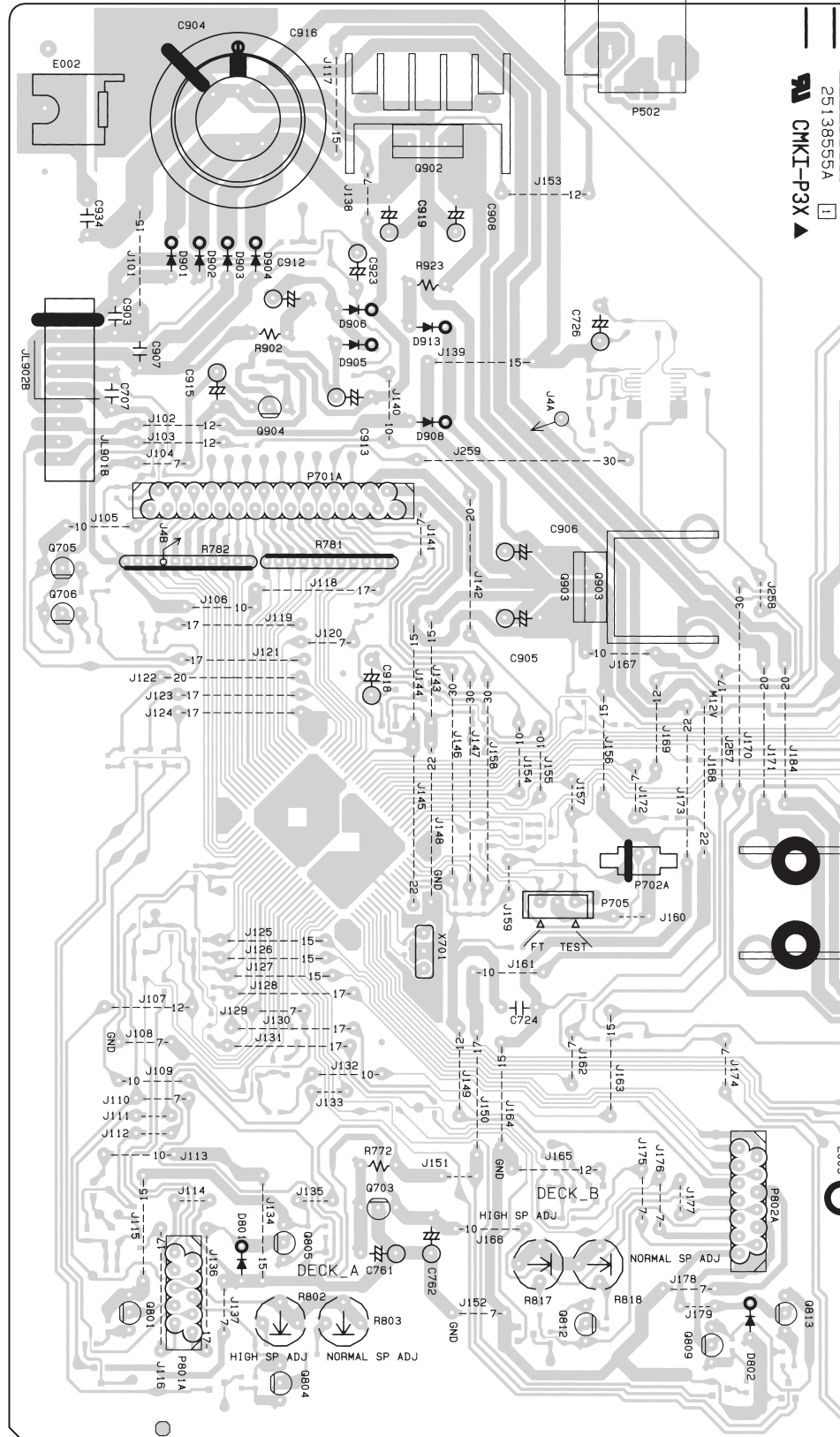

25138555A  
 CMKI-P3X



E

F

G

H

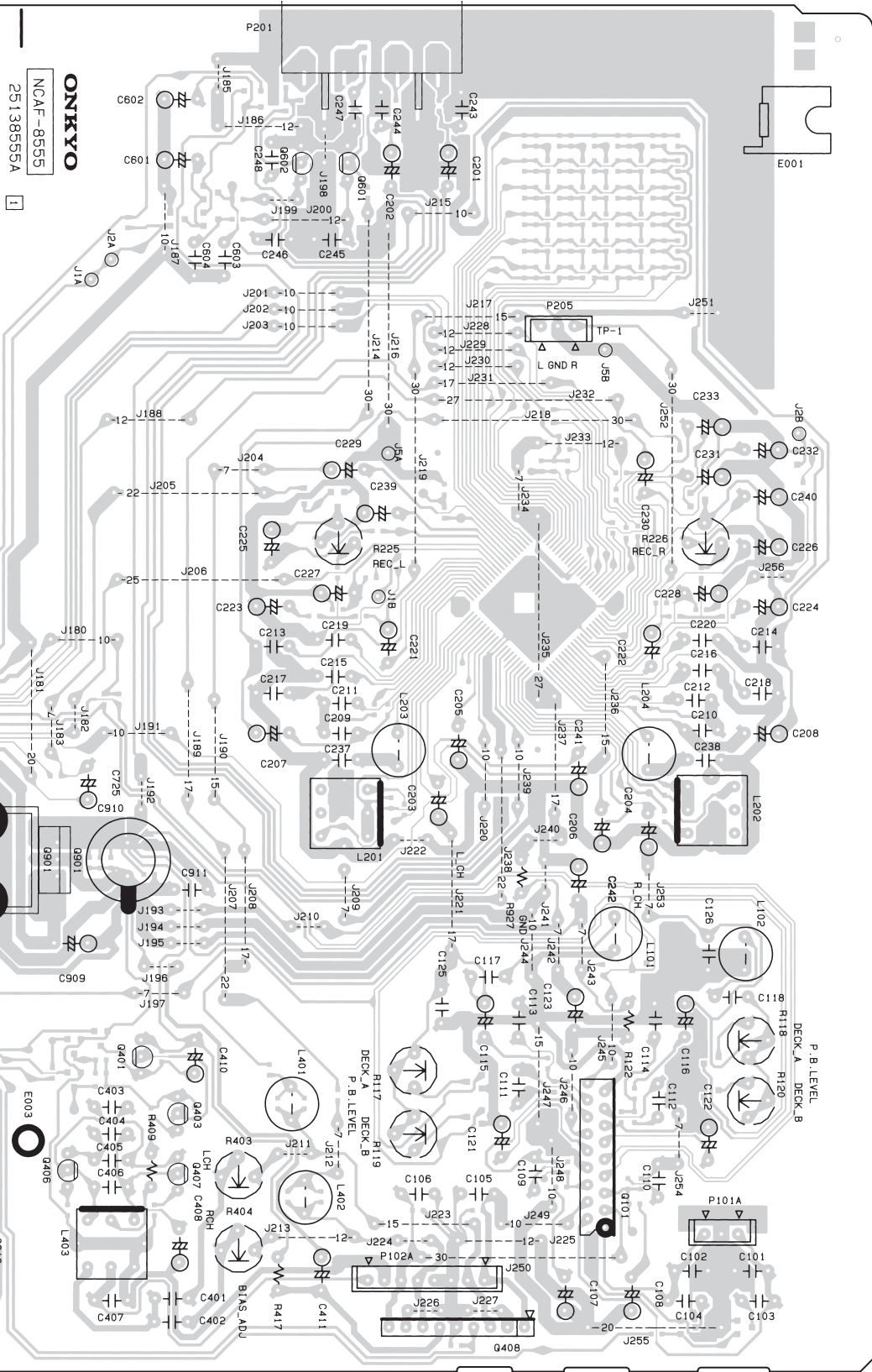

ONKYO  
NCAF-8555  
25138555A

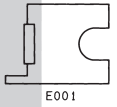

P.B.LEVEL  
DECK A  
DECK B



C101  
C102  
C103  
C104  
C108

J255

G408

R417

C411

J227

J226

J225

J249

J248

J247

J246

J245

J244

J243

J242

J241

J240

J239

J238

J237

J236

J235

J234

J233

J232

J231

J230

J229

J228

J227

J226

J225

J224

J223

J222

J221

J220

J219

J218

J217

J216

J215

J214

J213

J212

J211

J210

J209

J208

J207

J206

J205

J204

J203

J202

J201

J199

J198

J197

J196

J195

J194

J193

J192

J191

J190

J189

J188

J187

J186

J185

J184

J183

J182

J181

J180

J179

J178

J177

J176

J175

J174

J173

J172

J171

J170

J169

J168

J167

J166

J165

J164

J163

J162

J161

J160

J159

J158

J157

J156

J155

J154

J153

J152

J151

J150

J149

J148

J147

J146

J145

J144

J143

J142

J141

J140

J139

J138

J137

J136

J135

J134

J133

J132

J131

J130

J129

J128

J127

J126

J125

J124

J123

J122

J121

J120

J119

J118

J117

J116

J115

J114

J113

J112

J111

J110

J109

J108

J107

J106

J105

J104

J103

J102

J101

J100

J99

J98

J97

J96

J95

J94

J93

J92

J91

J90

J89

J88

J87

J86

J85

J84

J83

J82

J81

J80

J79

J78

J77

J76

J75

J74

J73

J72

J71

J70

J69

J68

J67

J66

J65

J64

J63

J62

J61

J60

J59

J58

J57

J56

J55

J54

J53

J52

J51

J50

J49

J48

J47

J46

J45

J44

J43

J42

J41

J40

J39

J38

J37

J36

J35

J34

J33

J32

J31

J30

J29

J28

J27

J26

J25

J24

J23

J22

J21

J20

J19

J18

J17

J16

J15

J14

J13

J12

J11

J10

J9

J8

J7

J6

J5

J4

J3

J2

J1

J0

J-1

J-2

J-3

J-4

J-5

J-6

J-7

J-8

J-9

J-10

J-11

J-12

J-13

J-14

J-15

J-16

J-17

J-18

J-19

J-20

J-21

J-22

J-23

J-24

J-25

J-26

J-27

J-28

J-29

J-30

J-31

J-32

J-33

J-34

J-35

J-36

J-37

J-38

J-39

J-40

J-41

J-42

J-43

J-44

J-45

J-46

J-47

J-48

J-49





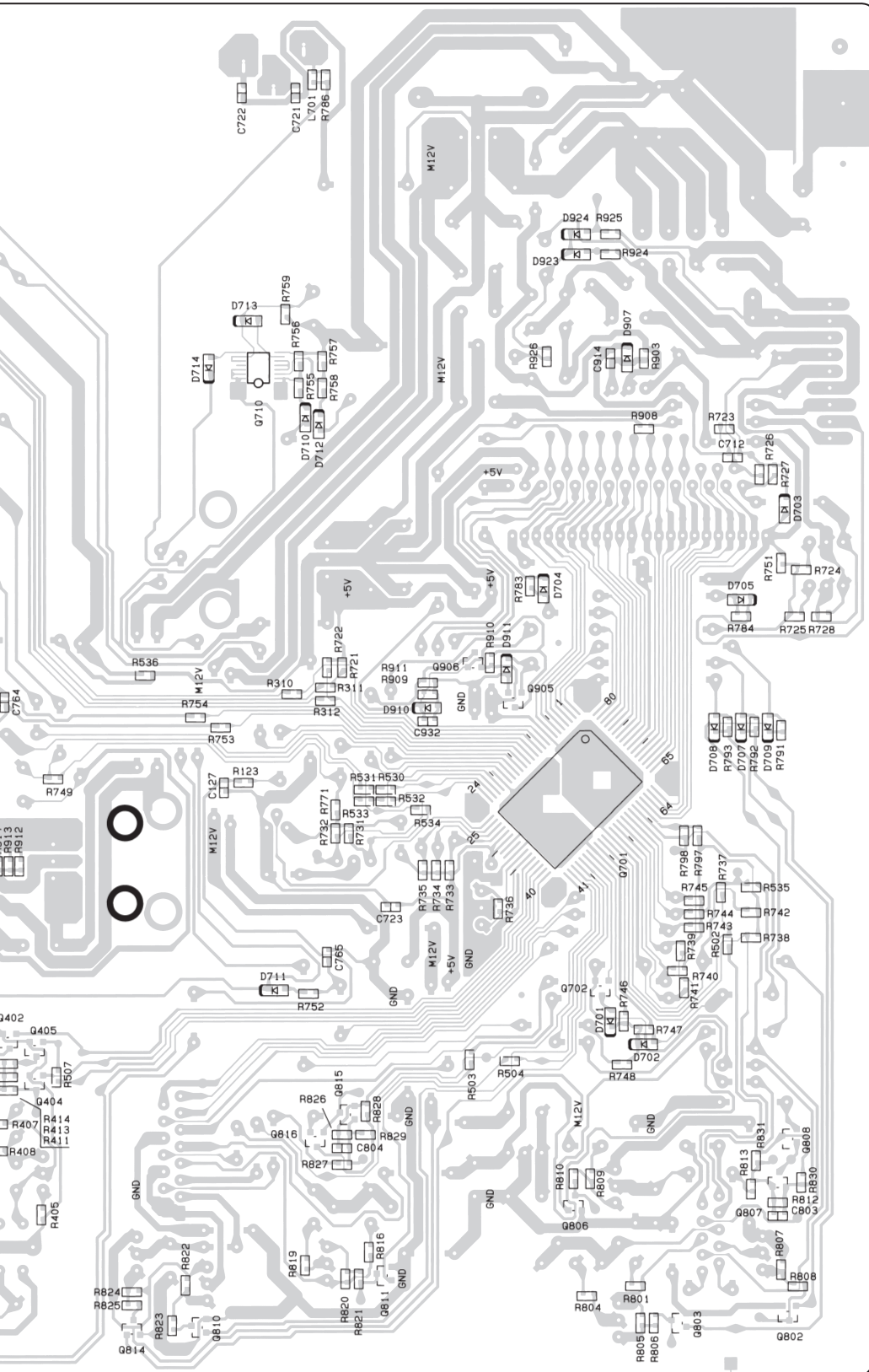

A

B

C

D

PRINTED CIRCUIT BOARD VIEWS-3

**U02** DISPLAY CIRCUIT PC BOARD (NADIS-8556)

Component side view from soldering side

1

2

3

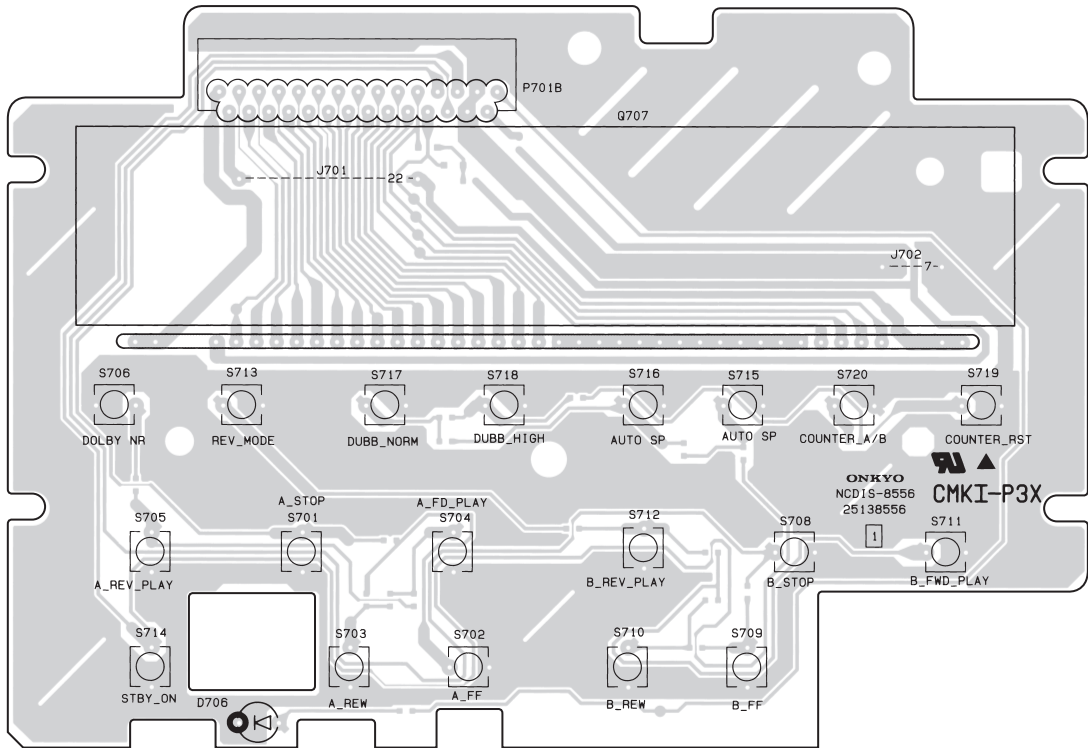

Soldering side

4

5

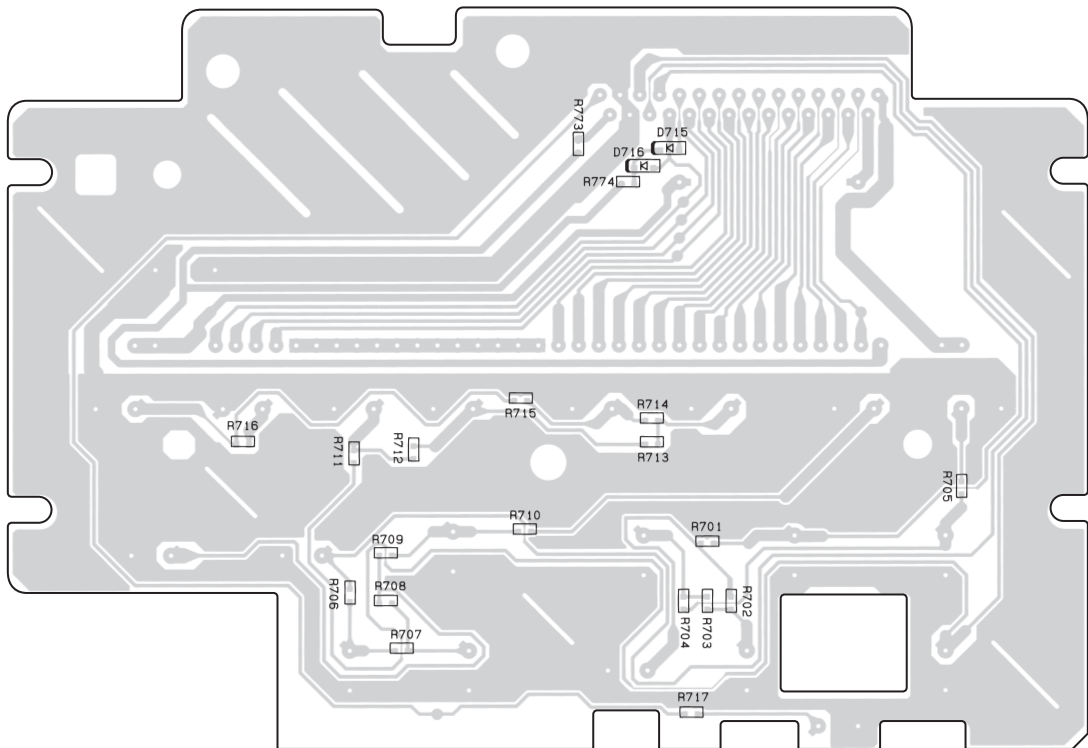

A

B

C

D

# PRINTED CIRCUIT BOARD VIEWS-4

## U03 POWER SUPPLY PC BOARD (NAPS-8557)

Component side view from soldering side

1

2

3

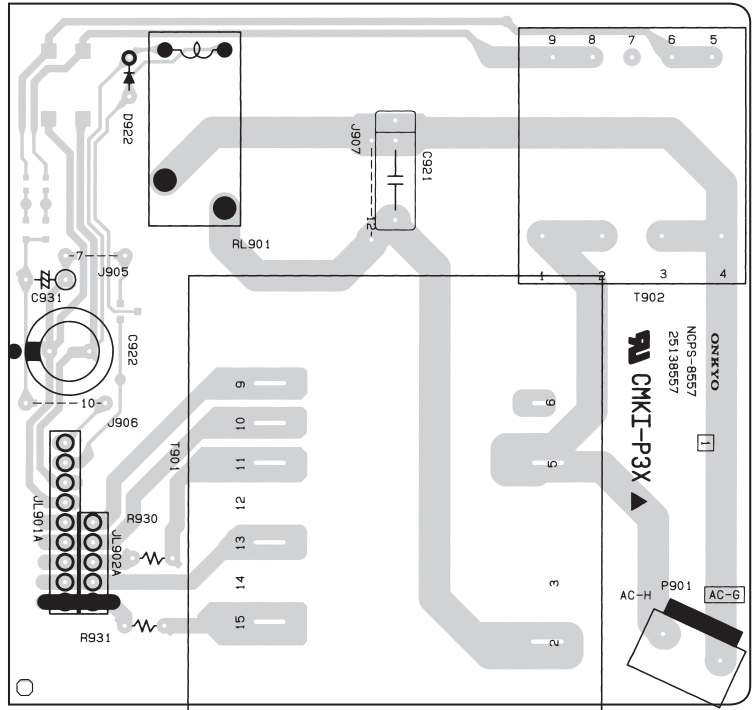

Soldering side

4

5

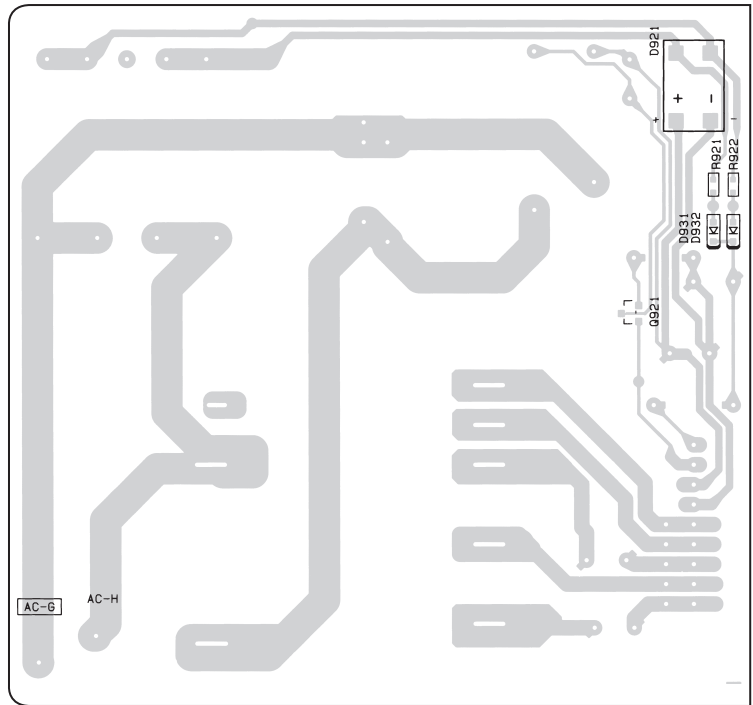

A

B

C

D

PRINTED CIRCUIT BOARD VIEWS-5

1

**U04** INPUT VOLUME PC BOARD (NAETC-8558)

Component side view from soldering side

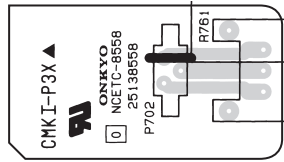

2

**U05** POWER SWITCH PC BOARD (NASW-8559)

EXCEPT <MDD>

Component side view from soldering side

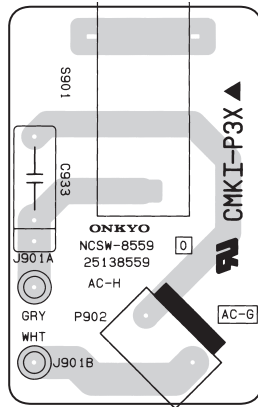

3

4

5

A B C D E F G H

PRINTED CIRCUIT BOARD VIEWS-1

**U01 MAIN PC BOARD (NAAF-8555)**  
Component side view from soldering side

1  
2  
3  
4  
5

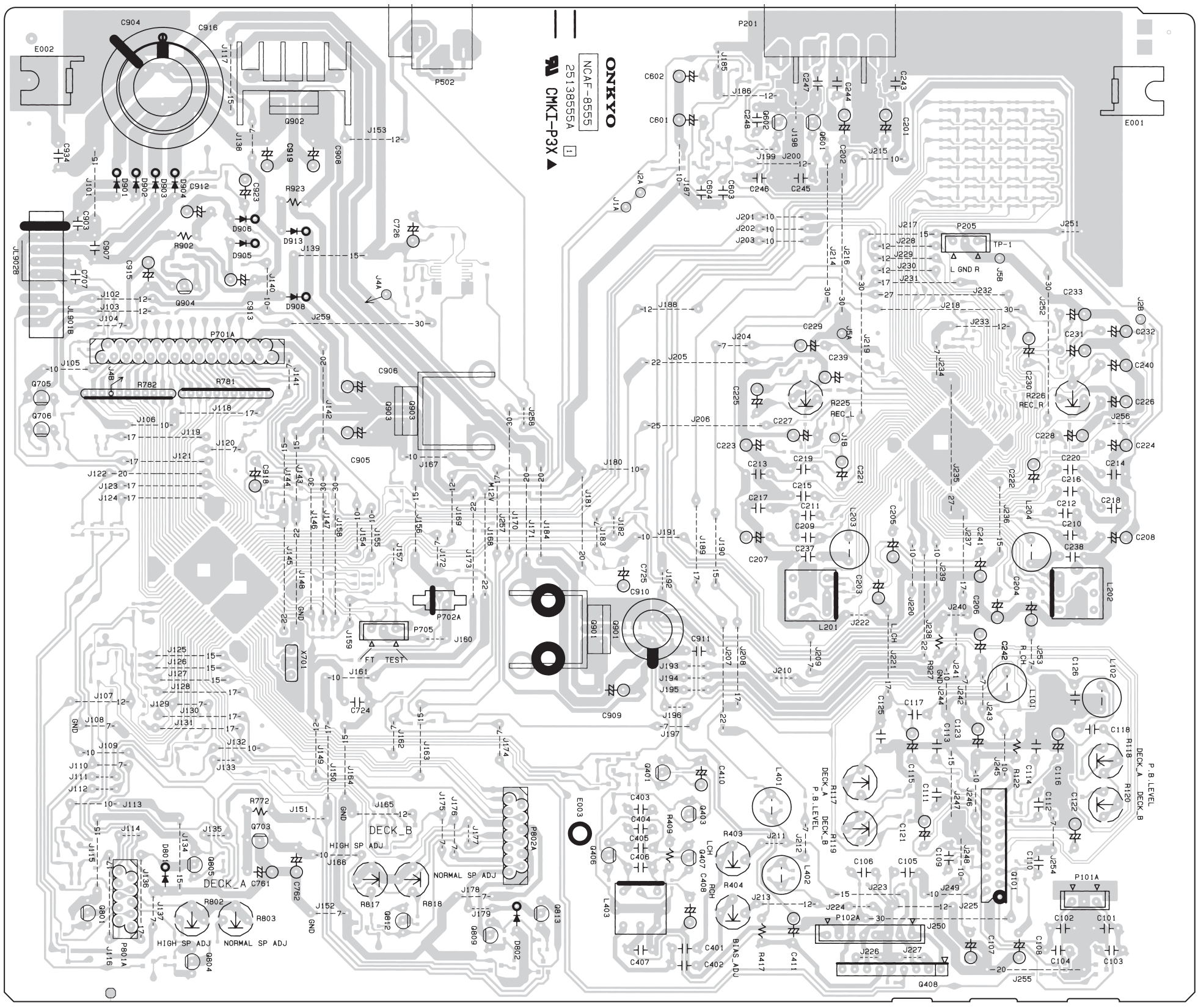





# IC BLOCK DIAGRAM/TERMINAL DESCRIPTION

## Q101 : BA3416BL DUAL PLAYBACK PRE\_AMPLIFIER

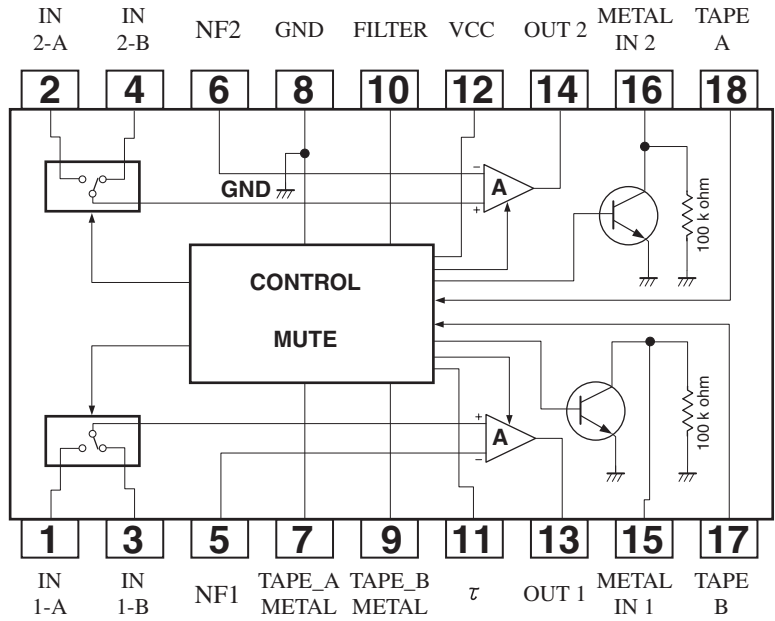





---

## HA12167FB/HA12169FB

---

### Ordering Information

Type	Package	PB-OUT Level	REC-OUT Level	Dolby Level	Operating Voltage	
					Min	Max
HA12167FB	QFP-80	775 mVrms	300 mVrms	300 mVrms	12.0 V	15.0 V
HA12169FB	(14 × 14)	580 mVrms			11.0 V	15.0 V

\* Dolby is a trade mark of Dolby Laboratories Licensing Corporation.  
A license from Dolby Laboratories Licensing Corporation is required for the use of this IC.

## HA12167FB/HA12169FB

**Pin Description** ( $V_{CC} = 14\text{ V}$ ,  $T_a = 25^\circ\text{C}$ , No signal, The value in the show typical value.)

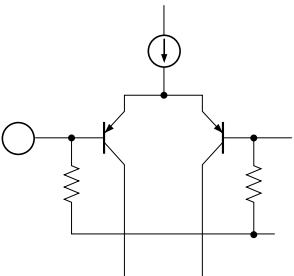
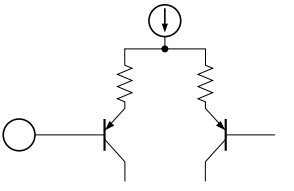
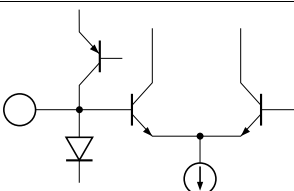
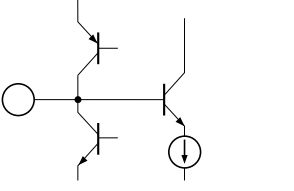
Pin No. (QFP-80)	Terminal Name	Zin	DC Voltage	Equivalent Circuit	Description
65	RPI	100 k	$V_{CC}/2$		Recording input
76					
9	LM IN	100 k			Level meter input
52					
12	EQ IN	100 k			Equalizer input
49					
66, 67, 69	VRI	100 k	$V_{CC}/2 + 0.7\text{ V}$		Volume input
72, 74, 75					
30, 31	VCC	—	$V_{CC}$	—	Power supply
77	REF	—	$V_{CC}/2$	—	Ripple filter
62	NR IN	—	$V_{CC}/2$		NR processor input
79					
3	SS 1	—	$V_{CC}/2$		Spectral skewing amp input
58					
5	CCR	—	$V_{CC}/2$		Current controlled resistor output
56					

## HA12167FB/HA12169FB

**Pin Description** ( $V_{CC} = 14\text{ V}$ ,  $T_a = 25^\circ\text{C}$ , No signal, The value in the show typical value.) (Cont)

Pin No. (QFP-80)	Terminal Name	Zin	DC Voltage	Equivalent Circuit	Description
63	IA OUT	—	$V_{CC}/2$		Input amp output
78					
61	VREF				Reference voltage
80					buffer output
2	PB OUT				Play back
59					(Decode) output
4	SS 2				Spectal skewing
57					amp. output
8	REC OUT				Recording
53					(Encode) output
15	EQ OUT				Equalizer output
46					
1	TP	1.5 k	$V_{CC}/2$		Bias trap terminal
60					
6	HLS DET	—	2.3 V		Time constant pin for rectifier
55					
7	LLS DET				
54					

**HITACHI**

## HA12167FB/HA12169FB

**Pin Description** ( $V_{CC} = 14\text{ V}$ ,  $T_a = 25^\circ\text{C}$ , No signal, The value in the show typical value.) (Cont)

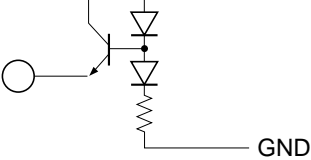
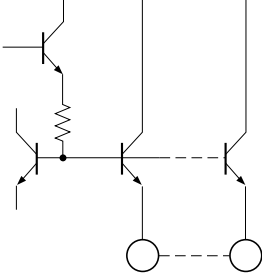
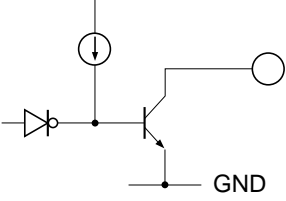
Pin No. (QFP-80)	Terminal Name	Zin	DC Voltage	Equivalent Circuit	Description
64	BIAS	—	0.28 V		Dolby NR reference current input
14	IREF	—	1.2 V		EQ reference current input
27	MF				EQ parameter
26	fQ				current input
25	f/Q				
24	GH				
23	GL				
22	GP				
35	BIAS ADJ (N)	—	1.2 V		Bias DAC
36	BIAS ADJ (M)				parameter current
37	BIAS ADJ (C)				input
21	HM	—	—		EQ parameter selector
20	HC				
19	HN				
18	NM				
17	NC				
16	NN				

## HA12167FB/HA12169FB

**Pin Description** ( $V_{CC} = 14\text{ V}$ ,  $T_a = 25^\circ\text{C}$ , No signal, The value in the show typical value.) (Cont)

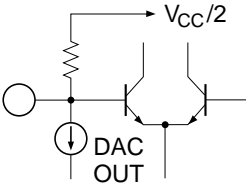
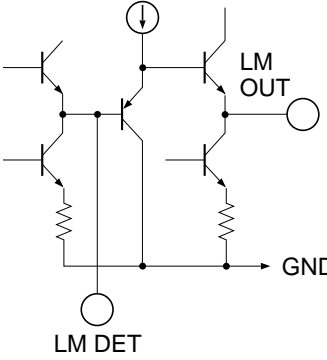
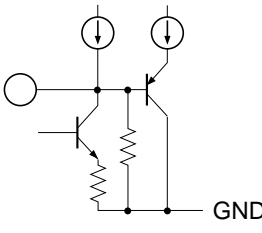
Pin No. (QFP-80)	Terminal Name	Zin	DC Voltage	Equivalent Circuit	Description
68	CONT	3.3 k	$V_{CC}/2 - 1.5\text{ V}$ to $V_{CC}/2$		DAC output volume control input
73					
13	EQ CONT	1.65 k			
48					
10	LM DET	—	0.2 V		Time constant pin for level meter
51					
11	LM OUT	—	0.2 V		Level meter output
50					
45	NR ON/OFF	100 k	—		Mode control time constant
44	C/B				
43	MPX				

**HITACHI**

## HA12167FB/HA12169FB

**Pin Description** ( $V_{CC} = 14\text{ V}$ ,  $T_a = 25^\circ\text{C}$ , No signal, The value in the show typical value.) (Cont)

Pin No. (QFP-80)	Terminal Name	Zin	DC Voltage	Equivalent Circuit	Description
42	RESET	100 k	—		Mode control input
41	STB				
40	DATA				
39	CLK				
38	INJ	—	0.7 V	—	Injection current input $I^2L$
47	D-GND	—	0.0 V	—	Digital (Logic) ground
70	GND	—	0.0 V	—	Ground
71, 34					
28	BIAS CONT	—	—		Bias DAC output
33					
29	DAC OUT	—	—		Bias DAC buffer out
32					





**Absolute Maximum Ratings**

Item	Symbol	Rating	Unit	Note
Supply voltage	$V_{CC}$ max	15	V	
Power dissipation	$P_d$	750	mW	1
Operating temperature	$T_{opr}$	-30 to +75	°C	
Storage temperature	$T_{stg}$	-55 to +125	°C	

Note: For  $T_a$  is higher than 65°C, reduce  $P_d$  at the rate of 12.5 mW/°C.  
Please, see the below graph.

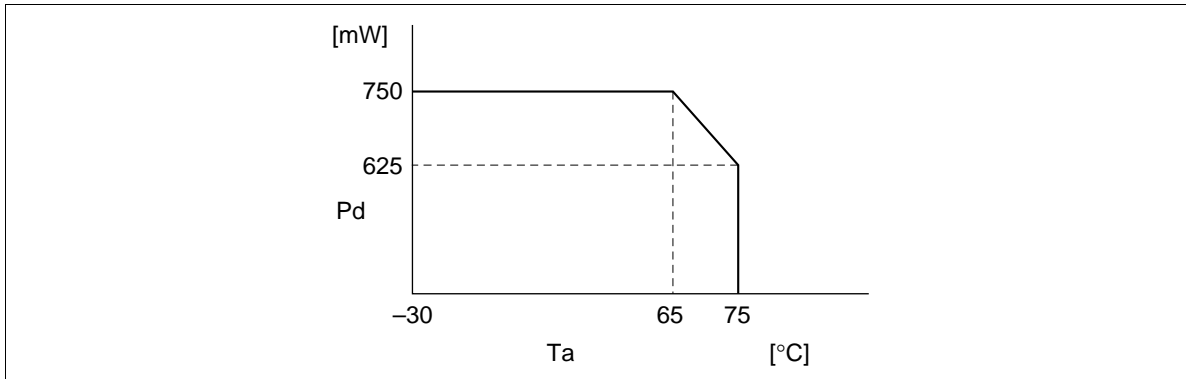

# HA12167FB/HA12169FB

Electrical Characteristics (Ta = 25°C, V<sub>CC</sub> = 14 V, Dolby Level 300 mV<sub>rms</sub> at REC/OUT)

Item	Symbol	Specification				Test Conditions														Application Terminal				Note	
		Min	Typ	Max	Unit	REC /PB	RV /PV	MPX	NR	B/C	Input Pin	Meter	Tape Speed	Tape	Input DAC	EQ DAC	Bias DAC	fin [Hz]	REC OUT Level	Input		Output			
																				R	L	R	L		
Quiescent current	I <sub>Q</sub>	—	34.5	42.0	mA	PB	PV	OFF	OFF	B	VRI1	NOR	NOR	NOR	32	0	0	—	—	No signal	—	—	—	—	30 31
Input amp. gain	G <sub>V</sub> IA RPI	18.5	20.0	21.5	dB	REC	RV	ON	OFF	B	RPI	NOR	NOR	NOR	63	0	0	1 k	0		76	65	78	63	
B-type encode boost	B-ENC -2 k	2.8	4.3	5.8	dB	REC	RV	ON	OFF → ON	B	RPI	NOR	NOR	NOR	63	0	0	2 k	-20		76	65	8	53	
	B-ENC -5 k	1.7	3.2	4.7		REC	RV	ON	OFF → ON	B	RPI	NOR	NOR	NOR	63	0	0	5 k	-20		76	65	8	53	
C-type encode boost	C-ENC -1 k (1)	3.9	5.9	7.9	dB	REC	RV	ON	OFF → ON	C	RPI	NOR	NOR	NOR	63	0	0	1 k	-20		76	65	8	53	
	C-ENC -1 k (2)	18.1	19.6	21.6		REC	RV	ON	OFF → ON	C	RPI	NOR	NOR	NOR	63	0	0	1 k	-60		76	65	8	53	
	C-ENC -700	9.8	11.8	13.8		REC	RV	ON	OFF → ON	C	RPI	NOR	NOR	NOR	63	0	0	700	-30		76	65	8	53	
Signal handling	V <sub>O</sub> Max	12.0	13.0	—	dB	REC	RV	ON	ON	C	RPI	NOR	NOR	NOR	63	0	0	1 k	—		76	65	8	53	1
Signal to noise ratio	S/N (C)	60.0	63.0	—	dB	REC	RV	ON	ON	C	RPI	NOR	NOR	NOR	63	0	0	—	—	Rg = 5.1 kΩ CCIR/ARM	76	65	8	53	
T.H.D.	THD (C)	—	0.08	0.3	%	REC	RV	ON	ON	C	RPI	NOR	NOR	NOR	63	0	0	1 k	0		76	65	8	53	
Crosstalk	CT (R ↔ L)	—	-85.0	-79.0	dB	REC	RV	ON	OFF	B	VPI1	NOR	NOR	NOR	0	0	0	1 k	6		72	69	8	53	
	CT (VRI1 ↔ VRI2)	—	-80.0	-74.0		REC	RV	ON	OFF	B	VRI1 ↔ VRI2	NOR	NOR	NOR	0	0	0	1 k	6		72/ 74	69/ 67	2	59	
	CT (VRI1 ↔ RPI)	—	-80.0	-74.0		REC	RV	ON	OFF	B	VRI1 ↔ RPI	NOR	NOR	NOR	0/63	0	0	1 k	6		72/ 76	69/ 65	2	59	

HITACHI

Electrical Characteristics (Ta = 25°C, Vcc = 14 V, Dolby Level 300 mVrms at RECOUT) (Cont)

Item	Symbol	Specification			Test Conditions													Application Terminal				Note						
		Min	Typ	Max	Unit	REC /PB	RV /PV	MPX	NR	B/C	Input Pin	Meter	Tape Speed	Tape	Input DAC	EQ DAC	Bias DAC	fin [Hz]	REC OUT Level	Input			Output					
																				R	L		R	L				
Serial digital input level	V <sub>S</sub> H	4.0	—	5.3	V	—	—	—	—	—	—	—	—	—	—	—	—	—	—	CLK, DATA, STB	—	—	—	—	39			
	V <sub>S</sub> L	-0.2	—	1.0		—	—	—	—	—	—	—	—	—	—	—	—	—	—	—	—	—	—	—	40 41			
PB-output level	V <sub>out</sub>	500	580	670	mVrms	REC	RV	ON	OFF	B	RPI	NOR	NOR	NOR	63	0	0	HA12167 1 k	HA12169 0	Low High	—	—	—	—	76	65	2	59
PB-out offset	V <sub>ofs</sub>	-100	0.0	+100	mV	PB	PV	OFF	OFF	C	RPI	NOR	NOR	NOR	63	0	0	—	—	No signal	—	—	2	59	2			
Channel balance	ΔG <sub>v</sub>	-1.0	0.0	1.0	dB	—	—	—	—	—	—	—	—	—	—	—	—	—	—	—	—	—	—	—	76	65	78	63
REC volume gain	G <sub>Vrec</sub> VR (Max)	17.5	19.1	21.5	dB	REC	RV	ON	OFF	B	VR11	NOR	NOR	NOR	0	0	0	1 k	—	Vin = 100 mVrms	72	69	78	63				
	G <sub>Vrec</sub> VR (Min)	-56.0	-50.0	-47.0	dB	REC	RV	ON	OFF	B	VR11	NOR	NOR	NOR	62	0	0	1 k	—	Vin = 2 Vrms	72	69	78	63				
PB volume gain	G <sub>VPB</sub> VR (Max)	27.0	29.0	31.0	dB	PB	PV	ON	OFF	B	VR11	NOR	NOR	NOR	0	0	0	1 k	—	Vin = 100 mVrms	72	69	78	63				
	G <sub>VPB</sub> VR (Min)	15.0	17.0	19.0	dB	PB	PV	ON	OFF	B	VR11	NOR	NOR	NOR	62	0	0	1 k	—	Vin = 100 mVrms	72	69	78	63				
REC volume mute level	C <sub>Trec</sub> VR (MUT)	—	-82	-75	dB	REC	RV	ON	OFF	B	VR11	NOR	NOR	NOR	63	0	0	1 k	—	Vin = 2 Vrms	72	69	2	59				
REC volume max input level	Vin max (VR)	11.0	12.0	—	dB	REC	RV	ON	OFF	B	VR11	NOR	NOR	NOR	42	0	0	1 k	—	THD = 1%	72	69	2	59				
Signal to noise ratio of REC volume	S/N (VR)	78.0	84.0	—	dB	REC	RV	ON	OFF	B	VR11	NOR	NOR	NOR	—	0	0	(1 k)	0	Vin = 100 mVrms Rg = 5.1 k, A-WTG	72	69	2	59	3			
T.H.D. of REC volume	THD (VR)	—	0.04	0.3	%	REC	RV	ON	OFF	B	VR11	NOR	NOR	NOR	—	0	0	1 k	0	Vin = 100 mVrms	72	69	2	59	3			

# HA12167FB/HA12169FB

Electrical Characteristics (Ta = 25°C, V<sub>CC</sub> = 14 V, Dolby Level 300 mV<sub>rms</sub> at RECOU<sub>T</sub>) (Cont)

Item	Symbol	Specification				Test Conditions														Application Terminal				Note	
		Min	Typ	Max	Unit	REC /PB	RV /PV	MPX	NR	B/C	Input Pin	Meter	Tape Speed	Tape	Input DAC	EQ DAC	Bias DAC	fin [Hz]	REC OUT Level	Input		Output			
																				R	L	R	L		
Equalizer gain	G <sub>V</sub> EQ (500)	23.5	25.5	27.5	dB	REC	RV	ON	OFF	B	RPI	NOR	NOR	NOR	63	0	0	500	—	Vin = -32 dBs	12	49	15	46	
	G <sub>V</sub> EQ (1 k)	23.5	25.5	27.5		REC	RV	ON	OFF	B	RPI	NOR	NOR	NOR	63	0	0	1 k	—	Vin = -32 dBs	12	49	15	46	
	G <sub>V</sub> EQ (5 k)	25.0	27.0	29.0		REC	RV	ON	OFF	B	RPI	NOR	NOR	NOR	63	0	0	5 k	—	Vin = -32 dBs	12	49	15	46	
	G <sub>V</sub> EQ (12 k)	31.0	33.5	36.0		REC	RV	ON	OFF	B	RPI	NOR	NOR	NOR	63	0	0	12 k	—	Vin = -32 dBs	12	49	15	46	
Equalizer volume variable a range	ΔG <sub>V</sub> EQ (1 k)	6	8	10	dB	REC	RV	ON	OFF	B	RPI	NOR	NOR	NOR	63	0/30	0	1 k	—	Vin = -32 dBs	12	49	15	46	
Equalizer max input level	Vin Max (EQ)	-10.0	-9.0	—	dBs	REC	RV	ON	OFF	B	RPI	NOR	NOR	NOR	63	16	0	1 k	—	THD = 1%	12	49	15	46	
Equalizer volume mute gain	G <sub>V</sub> EQ (MUT)	—	-75	-62	dB	REC	RV	ON	OFF	B	RPI	NOR	NOR	NOR	63	31	0	1 k	—	Vin = -9 dBs 1 kHz BPF	12	49	15	46	
Signal to noise ratio of equalizer	S/N (EQ)	57.0	62.0	—	dB	REC	RV	ON	OFF	B	RPI	NOR	NOR	NOR	63	0	0	—	—	Rg = 5.1 kΩ, A-WTG	12	49	15	46	
THD of equalizer	THD (EQ)	—	0.2	0.5	%	REC	RV	ON	OFF	B	RPI	NOR	NOR	NOR	63	16	0	1 k	—	Vin = -26 dBs	12	49	15	46	
Equalizer offset	Vofs (EQ)	-400	0.0	+400	mV	REC	RV	OFF	OFF	B	RPI	NOR	NOR	NOR	63	0	0	—	—	No signal	—	—	15	46	4
Level meter output	LM (0 dB)	2.50	2.75	3.00	V	REC	RV	ON	OFF	B	RPI	NOR	NOR	NOR	63	0	0	1 k	0		9	52	11	50	
	LM (12 dB)	3.55	3.85	4.15	V	REC	RV	ON	OFF	B	RPI	NOR	NOR	NOR	63	0	0	1 k	12		9	52	11	50	
	LM (-20 dB) <sup>1</sup>	0.70	1.00	1.30	V	REC	RV	ON	OFF	B	RPI	NOR	NOR	NOR	63	0	0	1 k	-20		9	52	11	50	
	LM (-20 dB) <sup>2</sup>	2.45	2.75	3.05	V	REC	RV	ON	OFF	B	RPI	20 dB	NOR	NOR	63	0	0	1 k	-20		9	52	11	50	

HITACHI

**Electrical Characteristics (Ta = 25°C, V<sub>CC</sub> = 14 V, Dolby Level 300 mV<sub>rms</sub> at RECOUT) (Cont)**

Item	Symbol	Specification			Unit	Test Conditions														Application Terminal				Note
		Min	Typ	Max		REC /PB	RV /PV	MPX	NR	B/C	Input Pin	Meter	Tape Speed	Tape	Input DAC	EQ DAC	Bias DAC	fin [Hz]	REC OUT Level	Input		Output		
																				R	L	R	L	
Level meter offset	LMofs 1	—	150	300	mV	REC	RV	ON	OFF	B	RPI	NOR	NOR	NOR	63	0	0	—	—	No signal	—	—	11	50
	LMofs 2	—	200	350		REC	RV	ON	OFF	B	RPI	20 dB	NOR	NOR	63	0	0	—	—	No signal	—	—	11	50
DAC output Max	V <sub>B</sub> Max	11.0	12.0	13.0	V	REC	RV	OFF	OFF	B	VR1	NOR	NOR	MET	63	0	63	—	—		—	—	29	32
DAC output Min	V <sub>B</sub> Min	—	0.5	1.0	V	REC	RV	OFF	OFF	B	VR1	NOR	NOR	MET	63	0	0	—	—		—	—	29	32

- Note: 1. HA12167: V<sub>CC</sub> = 12 V  
 HA12169: V<sub>CC</sub> = 11 V  
 2. V<sub>CC</sub> = 15 V  
 3. Adjust the input volume to Dolby level.  
 4. V<sub>CC</sub> = 15 V

# HA12167FB/HA12169FB

## Test Circuit

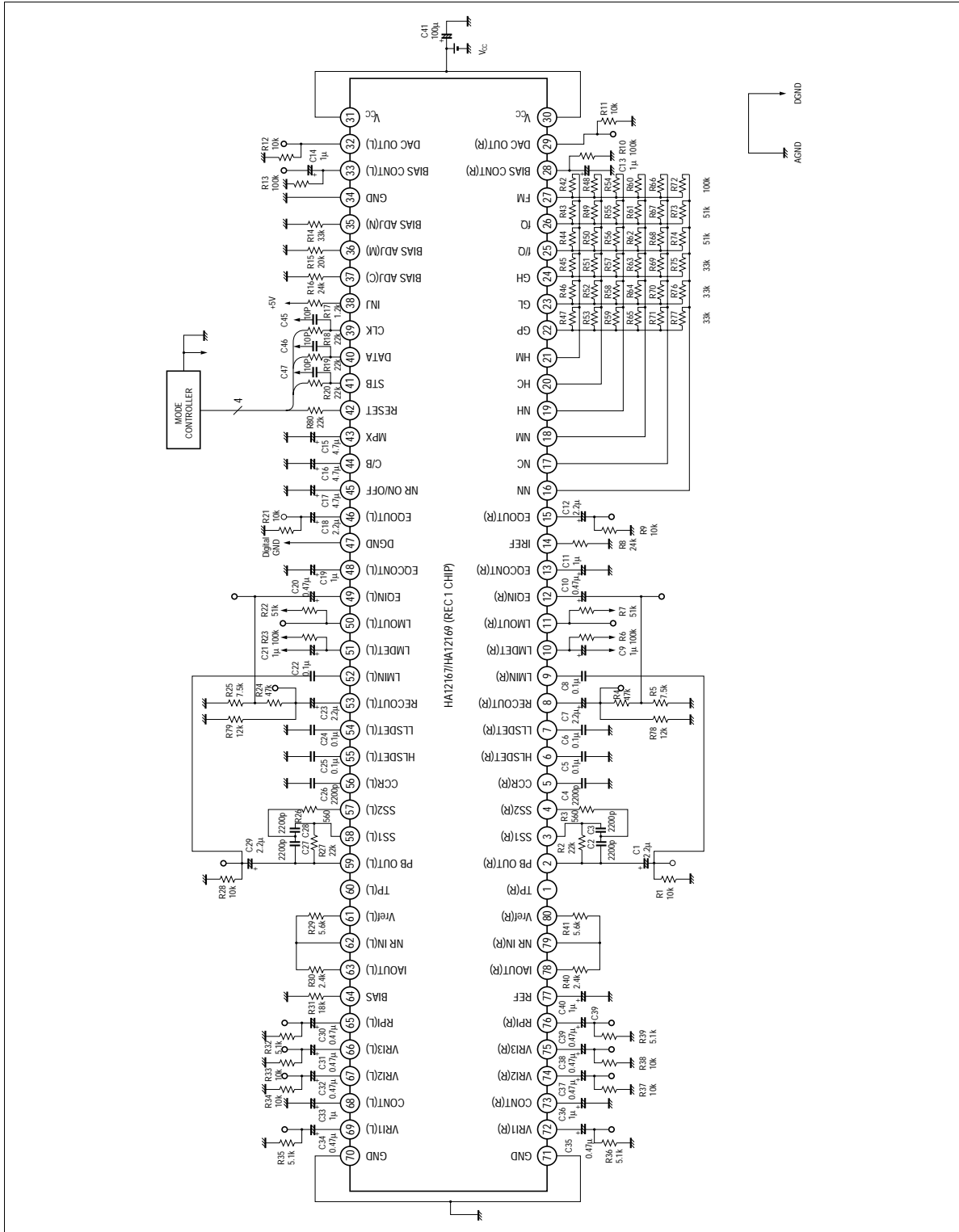

HITACHI



# HA12167FB/HA12169FB

## Mode Controller

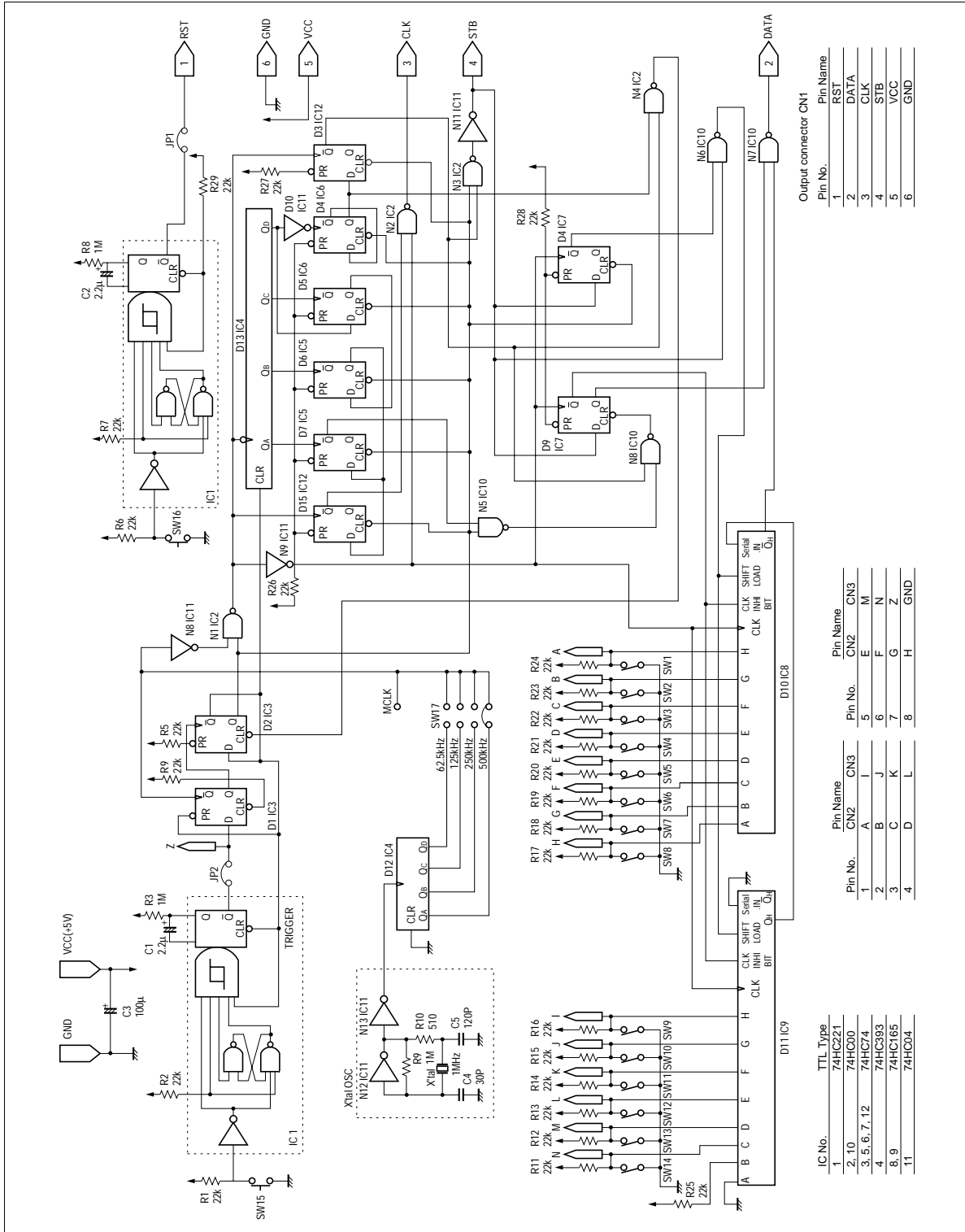

# HA12167FB/HA12169FB

## Level Diagram

REC Mode (1 kHz NR-OFF)

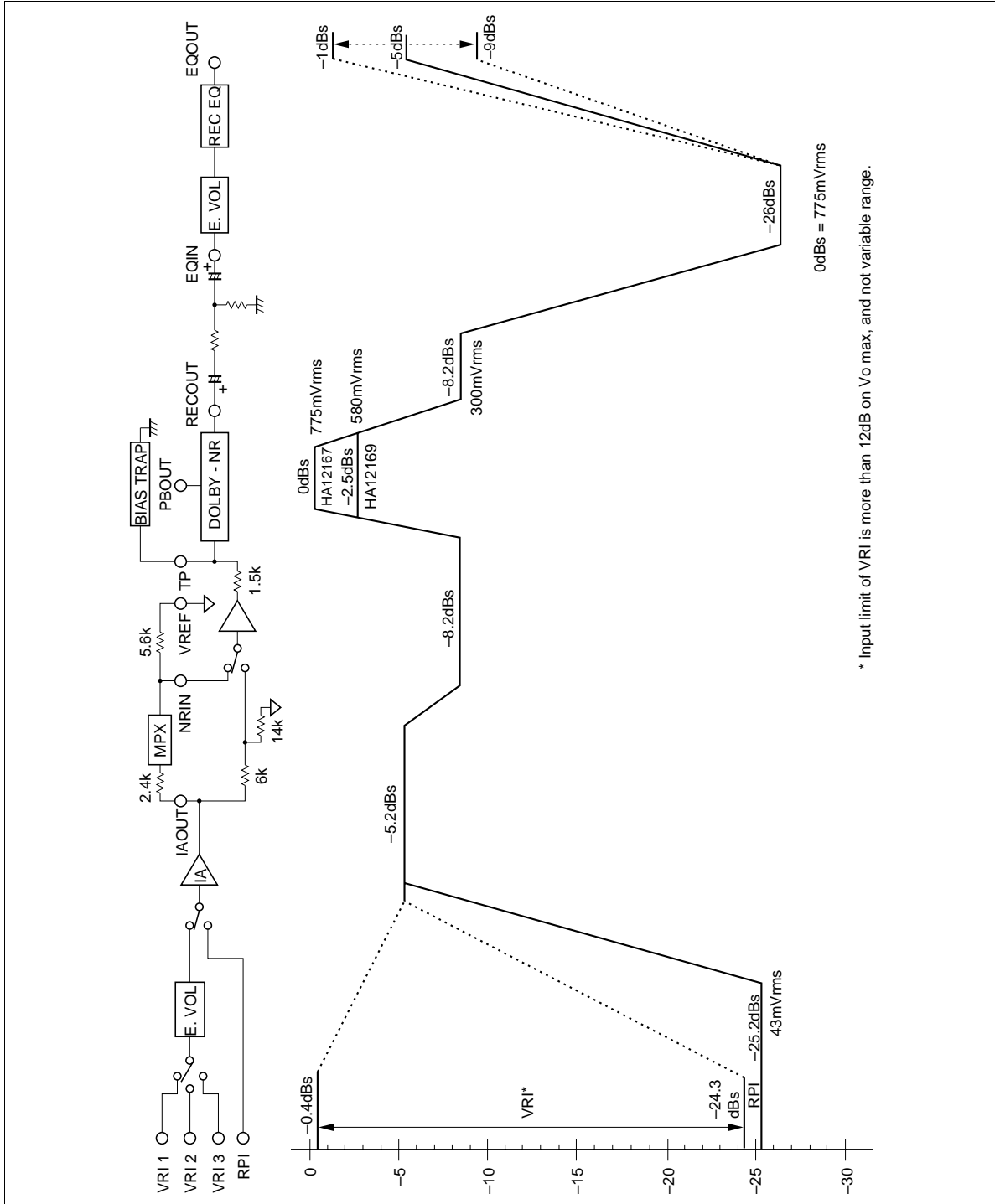

HITACHI

PB Mode (1 kHz NR-OFF)

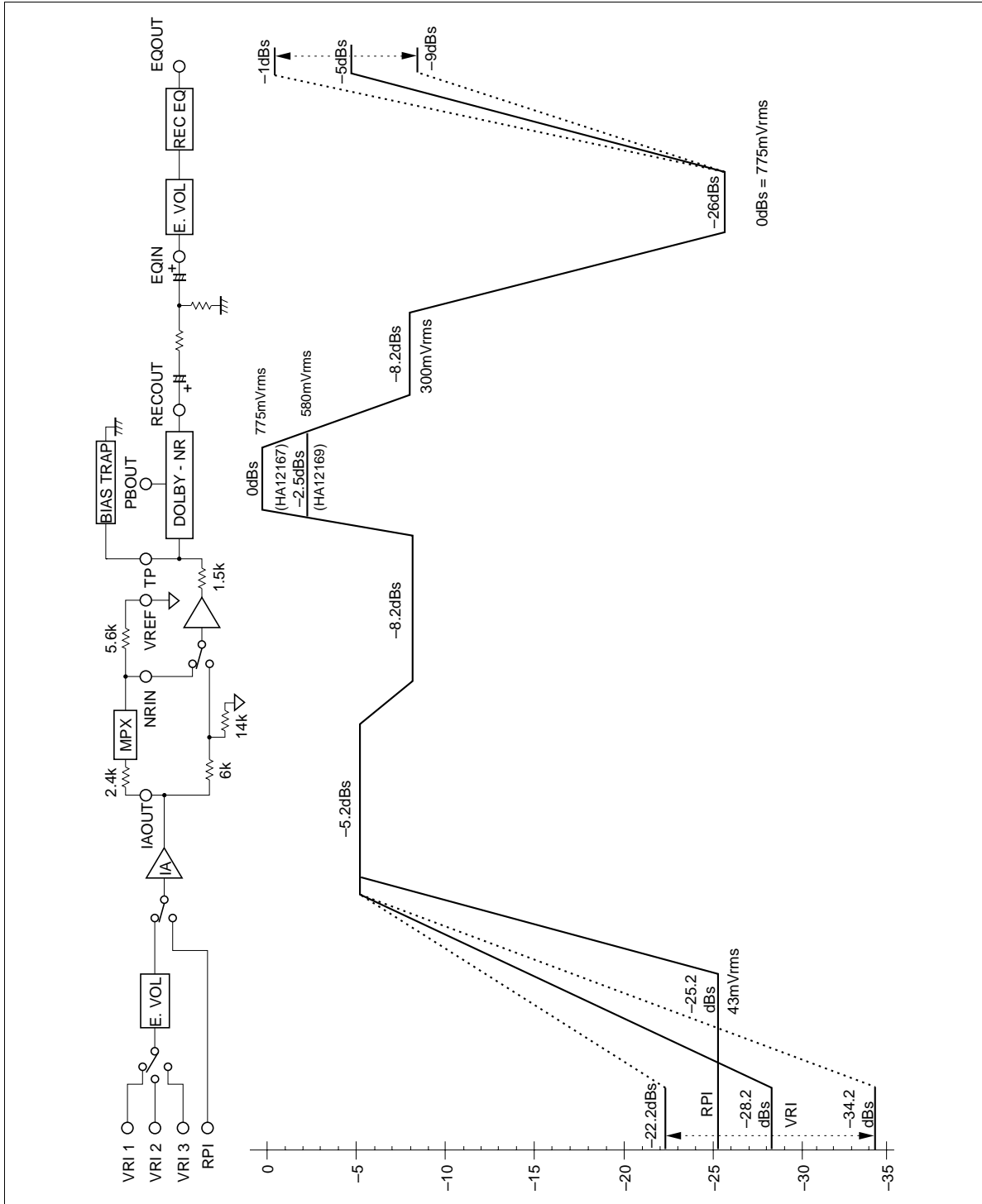

---

## HA12167FB/HA12169FB

---

### Application Note

#### Power Supply Range

HA12167FB/HA12169FB are designed to operate on either single supply or split supply.

The operating range of the supply voltage is shown in table 1.

**Table 1** Supply Voltage

Type No.	Single Supply	Split Supply
HA12167FB	12 V to 15 V	$\pm 6.0$ V to 7.5 V
HA12169FB	11 V to 15 V	$\pm 6.0$ V to 7.5 V

The lower limit of supply voltage depends on the line output reference level.

The minimum value of the overload margin is specified as 12 dB by Dolby Laboratories. HA12167 series are provided with two line output level, which will permit an optimum overload margin for power supply conditions.

#### Reference Voltage

For the single supply operation these devices provide the reference voltage of half the supply voltage that is the signal grounds. As the peculiarity of these devices, the capacitor for the ripple filter is very small about 1/100 compared with their usual value. The Reference voltage are provided for the left channel and the right channel separately. The block diagram is shown as figure 1.

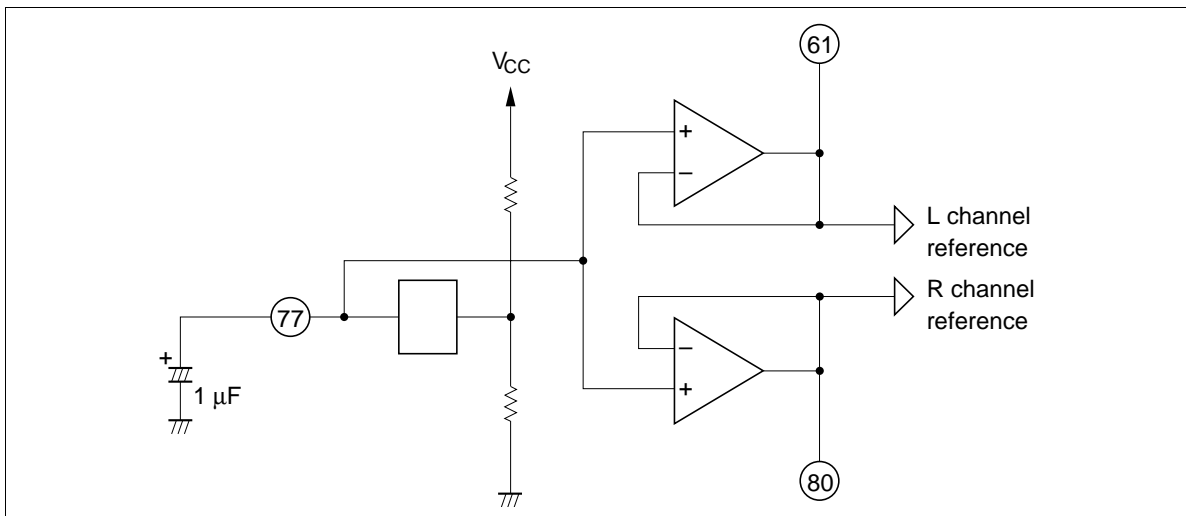

**Figure 1** The Block Diagram of Reference Voltage Supply

**HITACHI**

**Operating Mode Control**

HA12167FB/HA12169FB provides fully electronic switching circuits. All switches are controlled by serial data.

**Table 2     Threshold Voltage (VTH)**

Pin No.	Lo	Hi	Unit
42	-0.2 to 1.5	3.5 to 5.3	V
39, 40, 41	-0.2 to 1.0	4.0 to 5.3	V

Notes: 1. Voltages shown above are determined by internal circuits of LSI when take pin 47 (DGND pin) as reference pin. On split supply use, same VTH can be offered by connecting DGND pin to GND pin.

This means that it can be controlled directly by micro processor.

2. Each pins are on pulled down with 100 k internal resistor.  
Therefore, it will be low-level when each pins are open.
3. Note on serial data inputting
  - (a) The clock frequency on CLK must be less than 500 kHz.
  - (b) Over shoot level and under shoot level of input signal must be the value shown below.

When connecting microcomputer or Logic-IC with HA12167FB/HA12169FB directly, there is apprehension of rash-current under some transition timing of raising voltage or falling voltage at  $V_{CC}$  ON/OFF.

For this countermeasure, connect 10 k to 20 k resistor with each pins. It is shown in test circuit on this data sheet.

In case of changing NR-ON/OFF at the C-mode, for the countermeasure of the noise of pop, perform the following processes.

In case of changing NR-OFF to NR-ON at C-mode. C-mode, NR-OFF → B-mode, NR-OFF → B-mode, NR-ON → C-mode, NR-ON.

In case of changing NR-ON to NR-OFF at C-mode. C-mode, NR-ON → B-mode, NR-ON → B-mode, NR-OFF → C-mode, NR-OFF.

## HA12167FB/HA12169FB

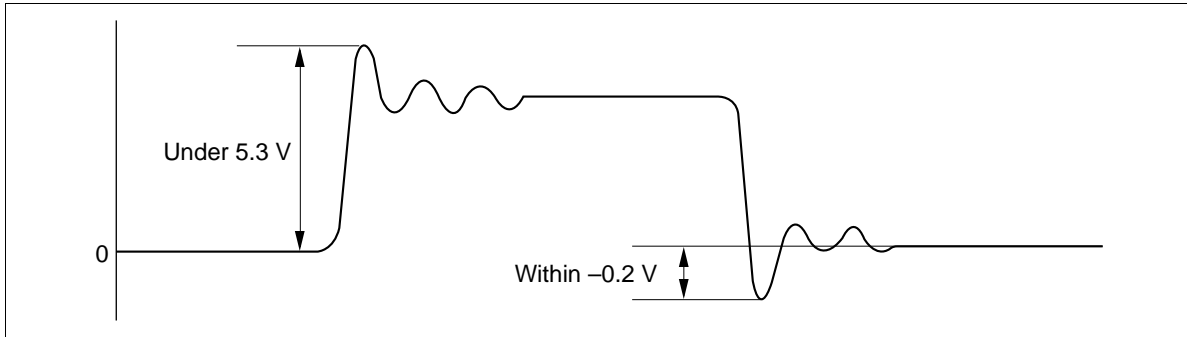

**Figure 2 Input Level**

### Serial Data Formatting

14 bit shift register is employed.

CLK and data are stored during STB being high and data is latched when STB goes high to low.

Reset goes reset a state when reset low and high releases reset. (High fixed at use time)

### Attention Point of Serial Interface

- Reset goes low condition when a power supply is ON or OFF.
- Characteristics select of Bias DAC is connected with equalizer tape selector.
- Bias DAC register is all low when a time of tape select.
- Bias DAC register is all low and Bias DAC out is dropped low level at compulsion by force.
- Input pin select, REC/PB select and Input volume gain select does not select at the same time.
- Input volume must go mute condition when selected of RPI is input pin select.

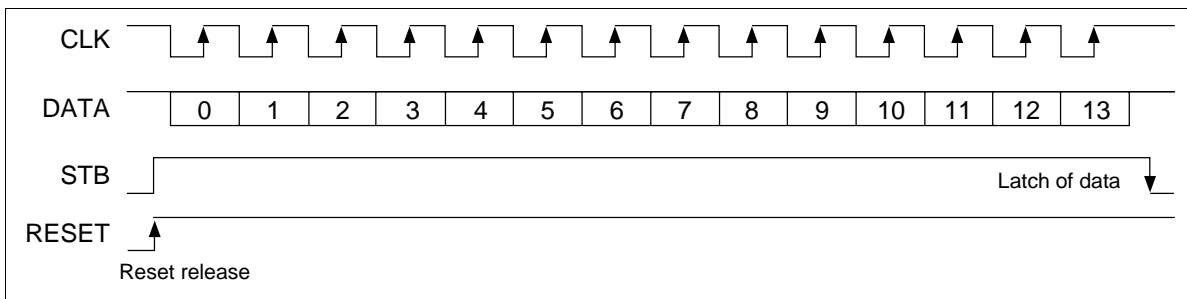

**Figure 3 Serial Data Timing Chart Figure**

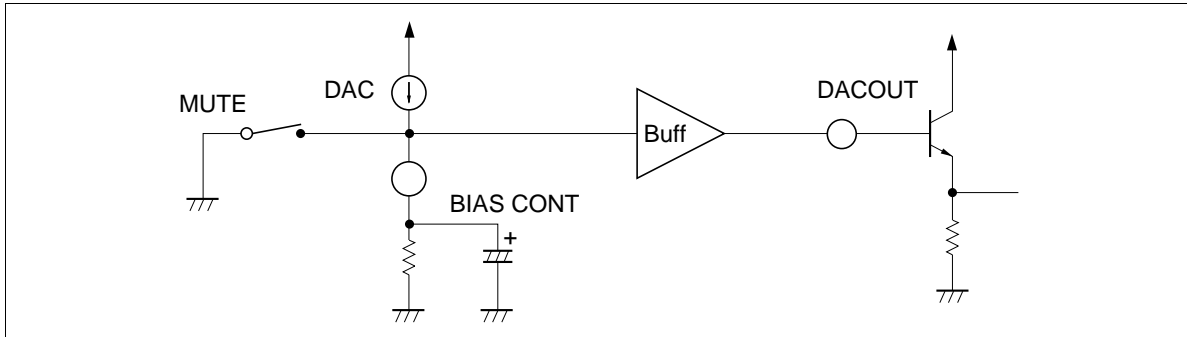

Figure 4 Bias DAC Output Circuit

# HA12167FB/HA12169FB

## Serial Data Formatting

Bit No.	Mode Control		Input Voltage		Equalizer Voltage		Basic DAC			
			Reset		Reset		Reset			
0	Tape selector 1	bit 0	L	L channel	I-bit 0 L	L channel	E-bit 0 L	L channel	B-bit 0 L	
		bit 1	H L							
		H	Metal Normal							
		L	Crom Normal							
1	Tape selector 2		L		I-bit 1 L		E-bit 1 L		B-bit 1 L	
2	Tape speed	H	Hi speed selection	L		I-bit 2 L		E-bit 2 L		B-bit 2 L
		L	Normal speed selection							
3	Meter sensitivity	H	Meter sensitivity 20 dB up	L		I-bit 3 L		E-bit 3 L		B-bit 3 L
		L	Meter sensitivity normal							
4	Input selector 1	bit 4	L		I-bit 4 L		E-bit 4 L		B-bit 4 L	
		bit 5	H L							
		H	VRI3 RPI							
		L	VRI2 VRI1							
5	Input selector 2		L		I-bit 5 H		— —		B-bit 5 L	
6	REC/PB	H	PB mode selection	H	R channel	I-bit 0 L	R channel	E-bit 0 L	R channel	B-bit 0
		L	REC mode selection							
7	Input voltage gain	H	PB mode volume gain	H		I-bit 1 L		E-bit 1 L		B-bit 1 L
		L	Rec mode volume gain							
8	MPX	H	ON	L		I-bit 2 L		E-bit 2 L		B-bit 2 L
		L	OFF							
9	NR	H	ON	L		I-bit 3 L		E-bit 3 L		B-bit 3 L
		L	OFF							
10	B/C	H	C	L		I-bit 4 L		E-bit 4 L		B-bit 4 L
		L	B							
11	—	—		—		I-bit 5 H		— —		B-bit 5 L
12	Register selector 1	bit 12								
		bit 13	H L							
		H	Bias DAC Input volume							
		L	Equalizer volume Mode control							
13	Register selector 2									



## HA12167FB/HA12169FB

### Input Volume Register

I-bit 5	I-bit 4	I-bit 3	I-bit 2	I-bit 1	I-bit 0	Gain
L	L	L	L	L	L	Increase
L	L	L	L	L	H	↑
L	L	L	L	H	L	:
L	L	L	L	H	H	:
:	:	:	:	:	:	:
:	:	:	:	:	:	↓
H	H	H	H	H	L	Decrease
H	H	H	H	H	H	Mute

### Equalizer Volume Register

E-bit 4	E-bit 3	E-bit 2	E-bit 1	E-bit 0	Gain
L	L	L	L	L	Increase
L	L	L	L	H	↑
L	L	L	H	L	:
L	L	L	H	H	:
:	:	:	:	:	:
:	:	:	:	:	↓
H	H	H	H	L	Decrease
H	H	H	H	H	Mute

### Bias DAC Register

B-bit 5	B-bit 4	B-bit 3	B-bit 2	B-bit 1	B-bit 0	Bias
L	L	L	L	L	L	Mute
L	L	L	L	L	H	Decrease
L	L	L	L	H	L	↑
L	L	L	L	H	H	:
:	:	:	:	:	:	:
:	:	:	:	:	:	:
H	H	H	H	H	L	↓
H	H	H	H	H	H	Increase

---

## HA12167FB/HA12169FB

---

### MPX ON/OFF Switch

MPX-OFF mode means that signal from input amp doesn't go through the MPX filter, but signal goes through the NR circuit after being attenuated 3 dB by internal resistor. Refer to figure 5. For not cause any level difference between MPX-ON mode and MPX-OFF mode, it is requested to use MPX-filter which has definitely 3 dB attenuated. And when applying other usage except figure 5,

take consideration to give bias voltage to NR-IN terminal by resistor or so on because internal of NR-IN terminal has no bias resistor.

### Application as for the Dubbing Cassette Deck

HA12167FB/HA12169FB series has unprocessor signal from recording out terminals during playback mode. So, it is simply applied for dubbing cassette decks.

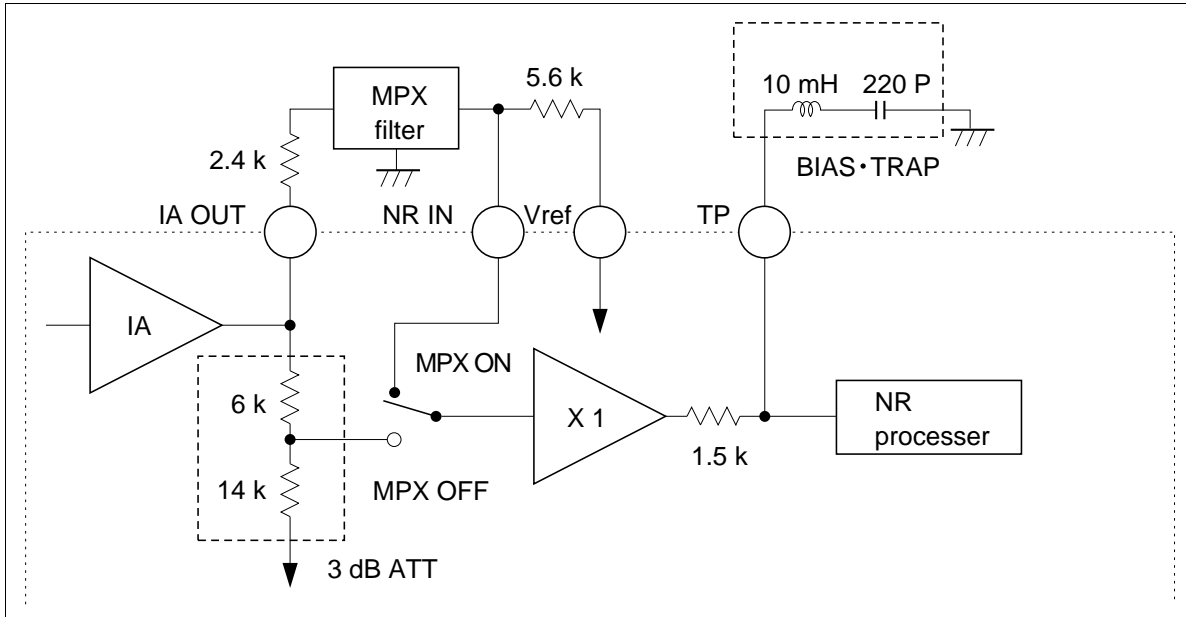
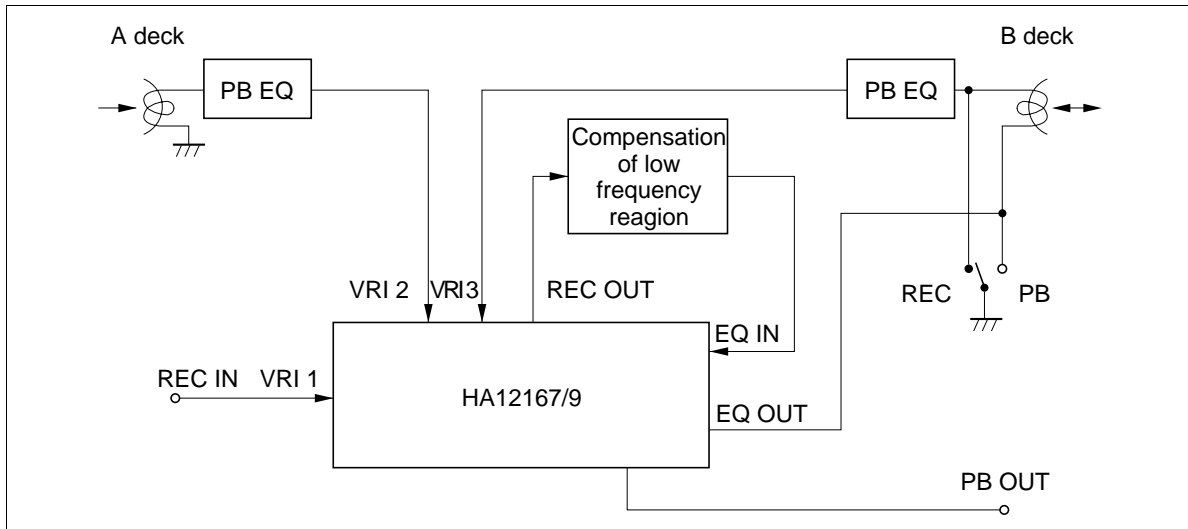

Figure 5 MPX ON/OFF Switch Block Diagram



**Figure 6 Application for Dubbing Deck**

**Injector Current**

HA12167FB/HA12169FB has logic circuit which is fabricated by I<sup>2</sup>L into IC. To operate this circuit, it is required enough injector current. Injector current goes into from the INJ pin (pin 38) and external resistor is required to connect to this pin for adequate current. The value of external resistor is obtained by using following equations. And put them with ±10% tolerance value which is calculated. V<sub>INJ</sub> can allow to connect to V<sub>CC</sub> shown below. Large injector current fear to cause mis-operation of Logic under the condition of high temperature. Also, small injector current fear to cause mis-operation (stop operation). Under the condition of low temperature. Therefore, pay attention to have good stability of V<sub>INJ</sub>.

$$R_{INJ} = \frac{V_{INJ} - 0.7}{3.6} \text{ [k}\Omega\text{]} \quad \text{Single supply}$$

$$R_{INJ} = \frac{V_{INJ} + V_{EE} - 0.7}{3.6} \text{ [k}\Omega\text{]} \quad \text{Split supply}$$

**Gain Control of Electronic Volume**

HA12167FB/HA12169FB is designed in order to change the gain by DAC fabricated into IC. To reduce the click noise when changing volume gain instantaneously, required to connect the capacitor and resistor (CR time constant) to CONT pin (pin 13, 48, 68, 73). These terminals are also be used as output pin of DAC. Therefore, by forcing voltage and current to these terminals, it is applicable to control volume gain directly. But, voltage forced to these terminals must be from V<sub>CC</sub>/2 - 2 V to V<sub>CC</sub>/2 (for split supply use, -2 V to 0 V) in this case. And, this case, change of a gain depending on a temperature gets large.

# HA12167FB/HA12169FB

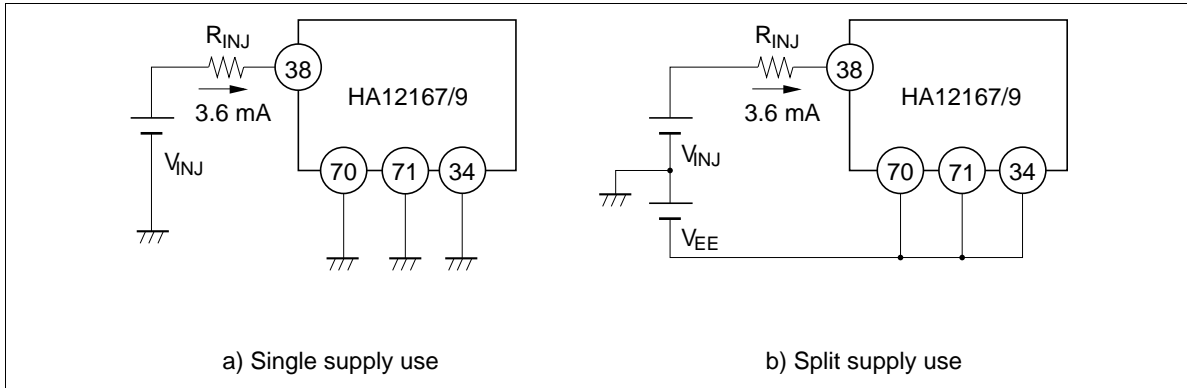
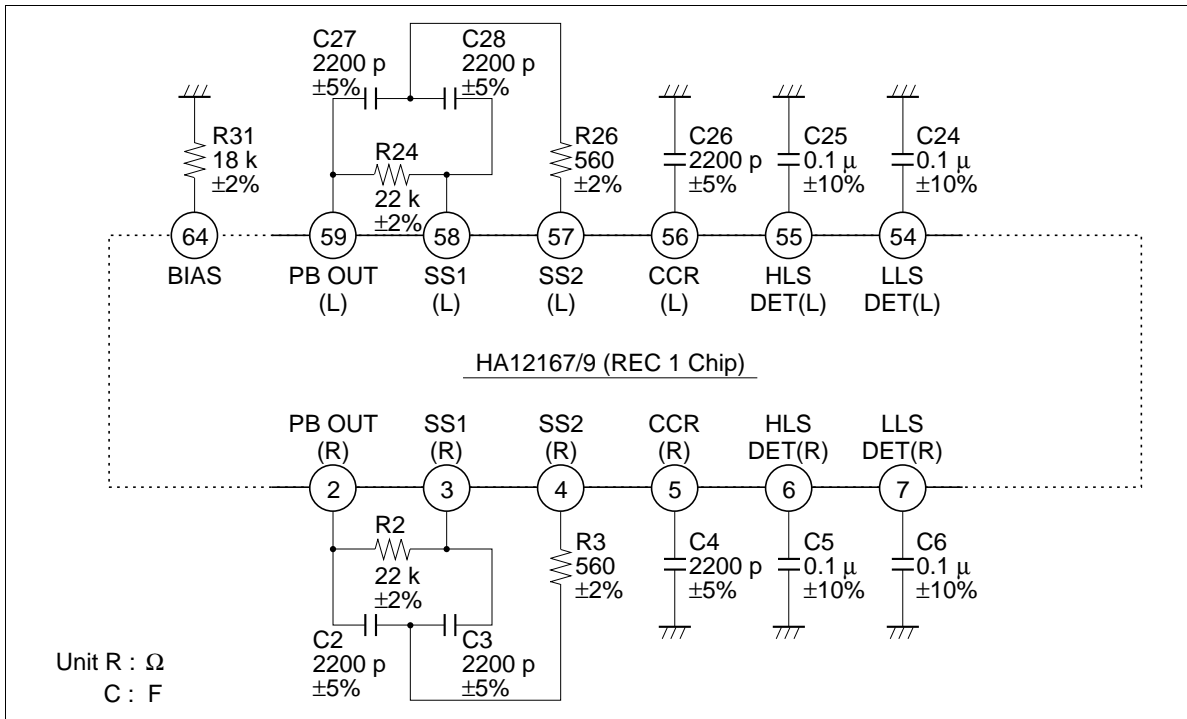

**Figure 7 Injector Current Application**

## The Tolerances of External Components for Dolby NR-Block

For adequate Dolby NR tracking response, take external components shown below.

For C5, C6, C24, and C25, please employ a few object of the leak, though you can be useful for an electrolytic-capacitor.



**Figure 8 Tolerances of External Components**

**BIAS DAC**

The full-scale of DAC is computed by the formula mentioned below.

$$V_{29} = \frac{2.4}{R_{14 \text{ to } 16}} \times R_{10} \text{ [V]}$$

$$V_{32} = \frac{2.4}{R_{14 \text{ to } 16}} \times R_{13} \text{ [V]}$$

R<sub>14</sub>: Normal Tape (pin 35)

R<sub>15</sub>: Metal Tape (pin 36)

R<sub>16</sub>: Chrome Tape (pin 37)

The maximum source current of DAC output (pin 29, 32) is 2 mA. Therefore the Bias-osc is driven through external transistor of emitter-follower.

**Level Meter**

The coupling capacitor of LMIN pin (9 pin and 52 pin).

For these capacitors, please employ a small object of the leak.

# HA12167FB/HA12169FB

## The Application of Equalizer Frequency Response

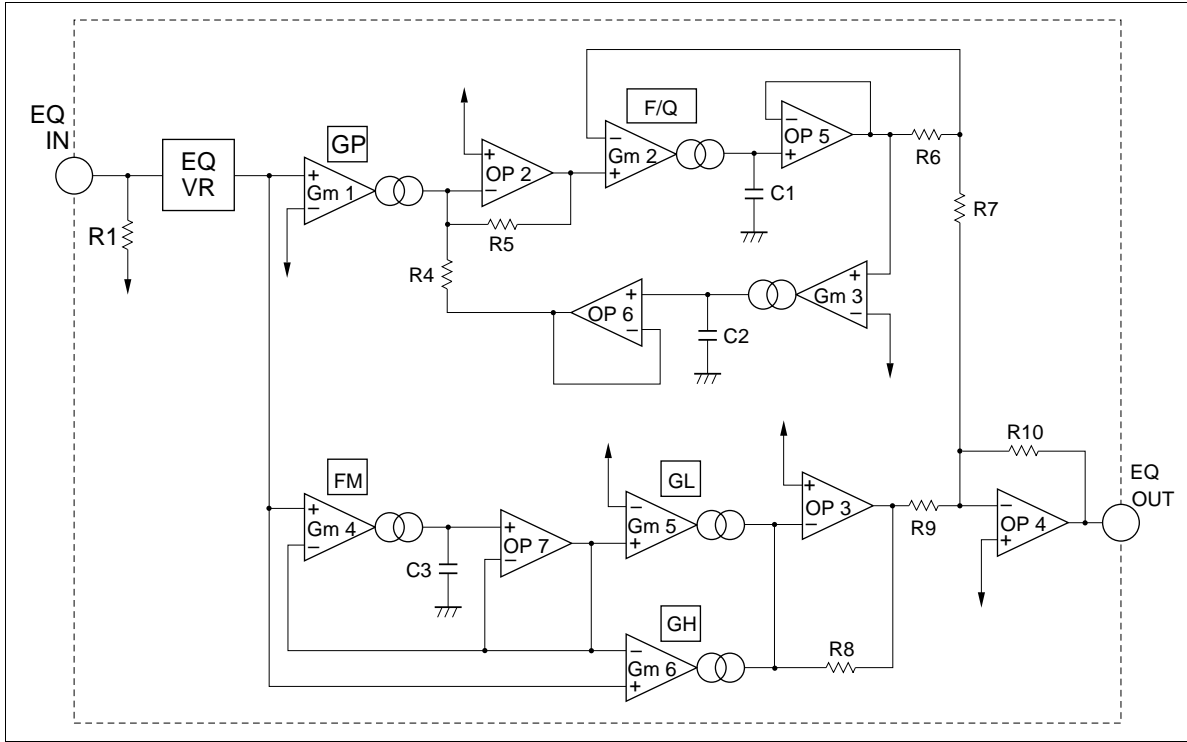

Figure 9 REC Equalizer Block Diagram

Transfer Function:

$$\frac{V_{out}}{V_{in}} = G_V \left( G_{m5} \cdot \frac{R_8 \cdot R_{10}}{R_9} \cdot \frac{1 + \frac{C_3 \cdot G_{m6}}{G_{m4} \cdot G_{m5}} \cdot S}{1 + \frac{C_3}{G_{m4}} \cdot S} + G_{m1} \cdot \frac{R_4 \cdot R_{10}}{R_6 + R_7} \cdot \frac{\frac{C_3}{G_{m4}} \cdot S}{1 + \frac{R_4}{R_5} \cdot \frac{R_7}{R_6 + R_7} \cdot \frac{C_2}{G_{m3}} \cdot S + \frac{R_4}{R_5} \cdot \frac{C_1}{G_{m2}} \cdot \frac{C_2}{G_{m3}} \cdot S^2} \right)$$

$$= \frac{9}{R_{REF}} \left( R_{GL} \cdot \frac{1 + 6.67 \times 10^{-10} \frac{R_{FM} \cdot R_{GH}}{R_{GL}} \cdot S}{1 + 6.67 \times 10^{-10} \frac{R_{GL}}{R_{FM}} \cdot S} + R_{GP} \cdot \frac{3.0 \times 10^{-10} \cdot R_{FQ} \cdot S}{1 + 4.5 \times 10^{-11} \cdot R_{FQ} \cdot S + 2.5 \times 10^{-20} \cdot R_{FQ} \cdot R_{F/Q} \cdot S^2} \right)$$

Note:  $R_{REF}$ .....14 pin bias resistance

$G_V$  .....Gain of EQ-VR

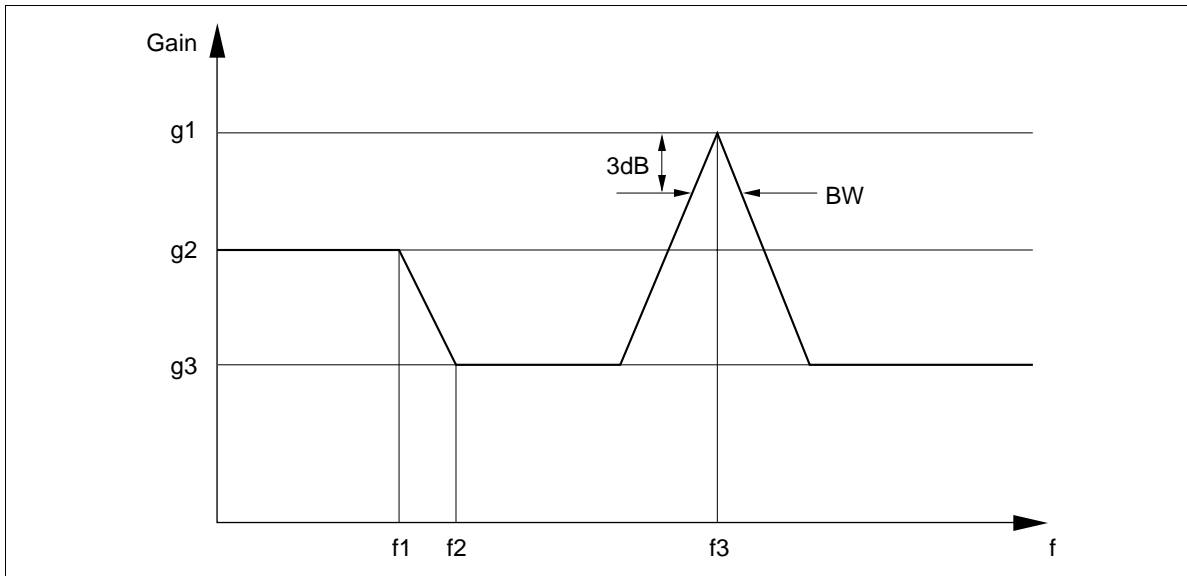

Figure 10 REC Equalizer Frequency Response

$$\left. \begin{aligned} g1 &= \frac{9}{R_{REF}} (6.67 \times R_{GP} + R_{GH}) \\ g2 &= \frac{9 \times R_{GL}}{R_{REF}} \\ g3 &= \frac{9 \times R_{GH}}{R_{REF}} \end{aligned} \right\} \text{when Gain of EQ - VR is center}$$

$$f1 = \frac{1}{2\pi \times 6.67 \times 10^{-10} \times R_{FM}}$$

$$f2 = \frac{R_{GL}}{2\pi \times 6.67 \times 10^{-10} \times R_{FM} \times R_{GH}}$$

$$f3 = \frac{1}{2\pi} \cdot \frac{0.3}{\sqrt{2.25 \times 10^{-21} \times R_{FQ} \times R_{F/Q}}}$$

$$BW = \frac{1}{4\pi \times 2.78 \times 10^{-10} \times R_{F/Q}}$$

$$Q = \frac{f3}{BW} = 3.51 \times \sqrt{\frac{R_{F/Q}}{R_{FQ}}}$$

# HA12167FB/HA12169FB

## Equalizer Characteristics Control Using a Bias DAC

When only one of the bias DAC channels is used, any one of the six parameters (FM, fQ, f/Q, GH, GL, and GP) that set the equalizer's characteristics can be controlled by the unused bias DAC.

The figure below gives one example.

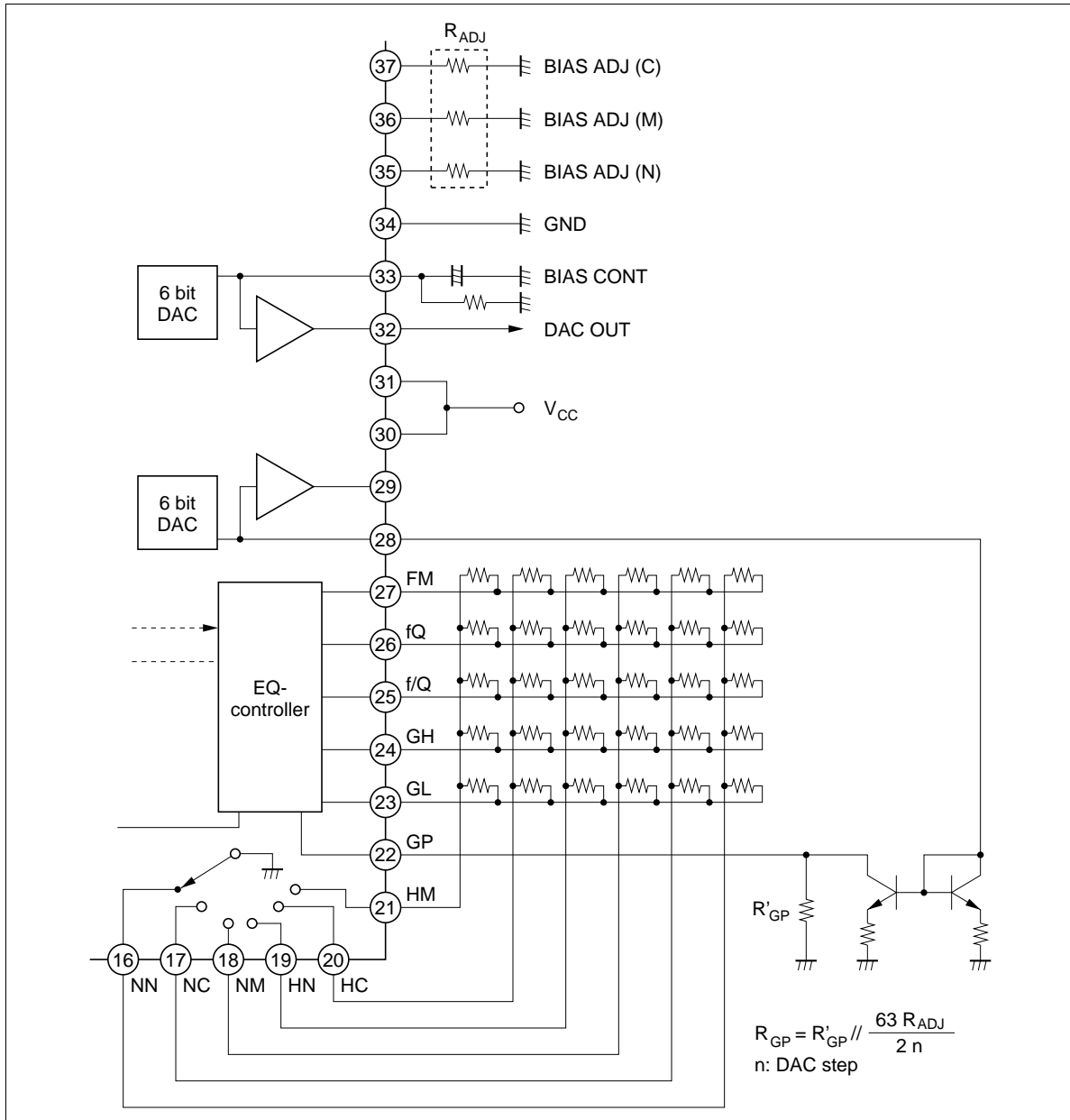
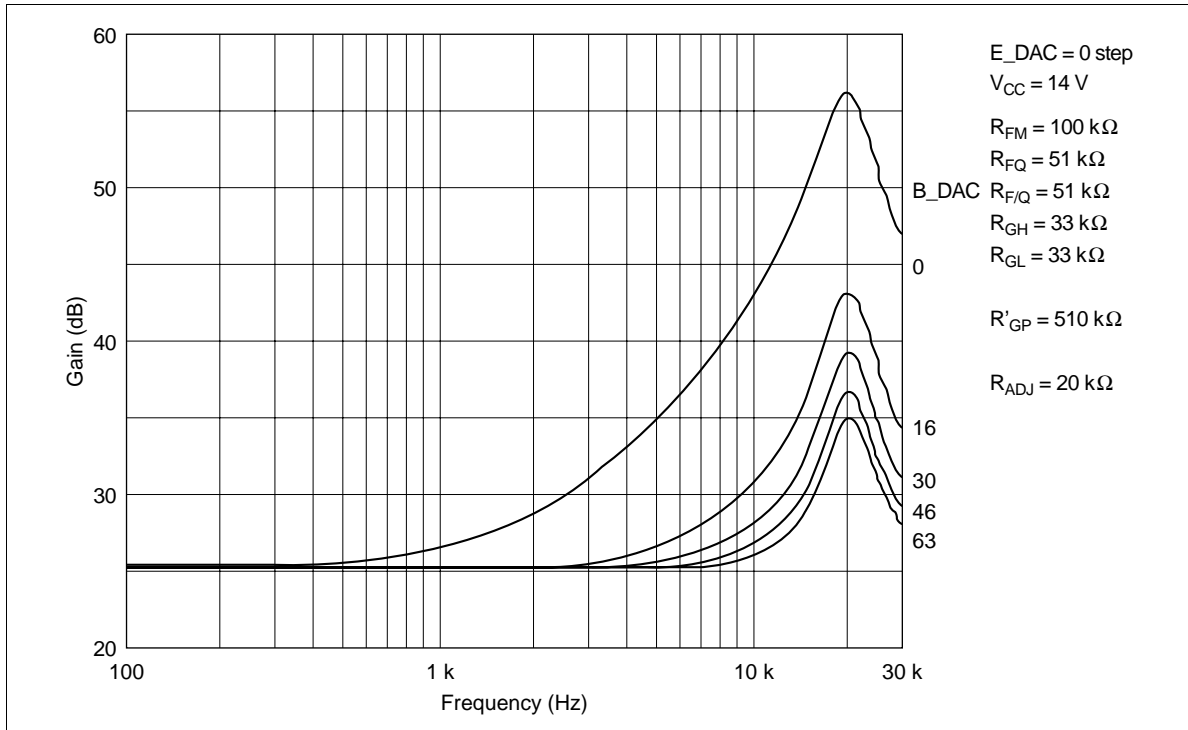

Figure 11 Bias DAC Control of the GP Parameter



Figures 12, 13, and 14 show the characteristics when GP is controlled by a bias DAC.



**Figure 12 Equalizer Gain vs. Frequency**

# HA12167FB/HA12169FB

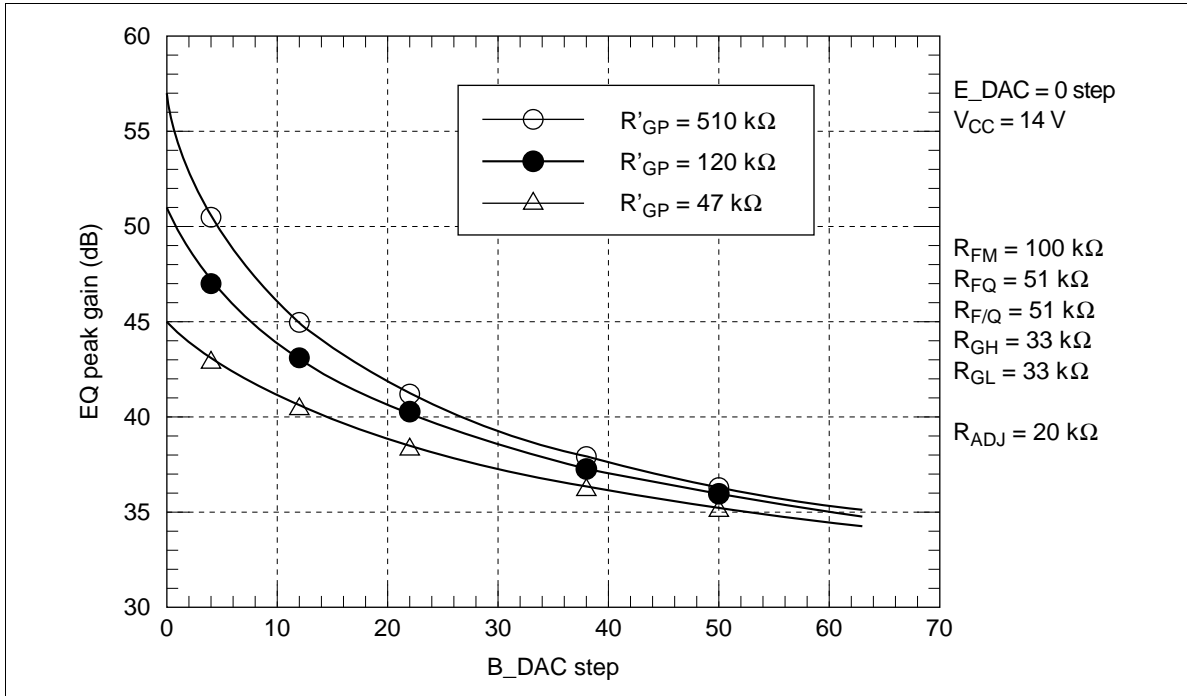

Figure 13 Equalizer Peak Gain vs. DAC Step Characteristics (1)

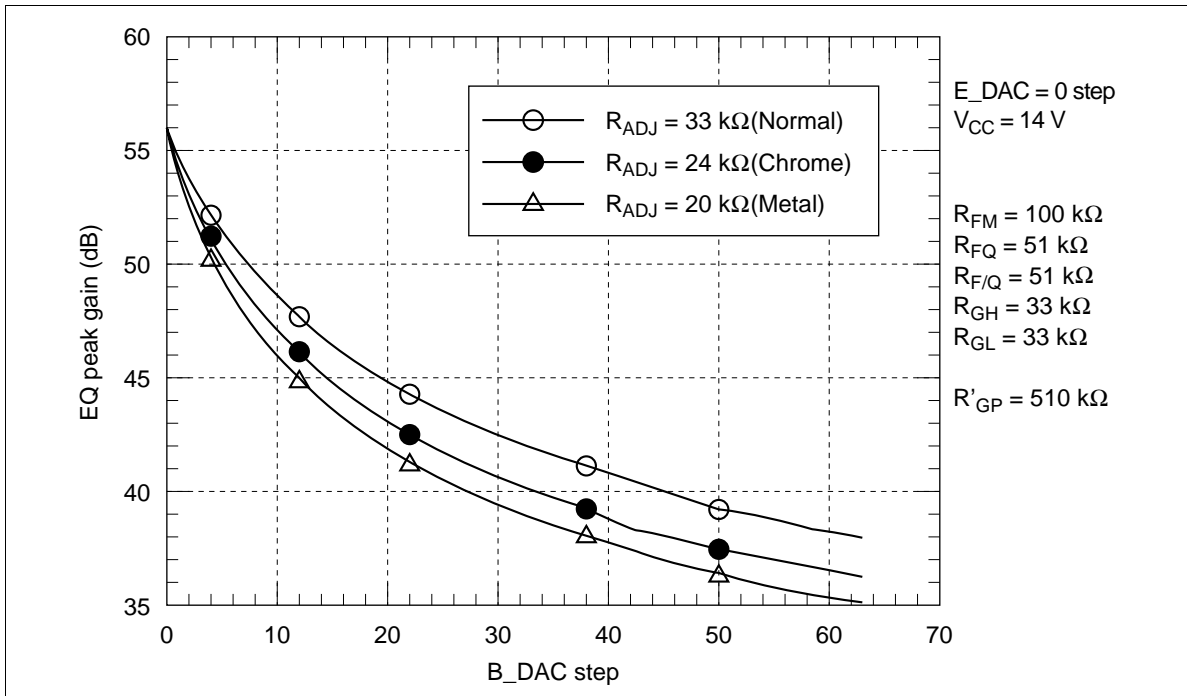

Figure 14 Equalizer Peak Gain vs. DAC Step Characteristics (2)

When the (variable) width of the DAC step is to be changed, the gain at step 0 or at step 63 must be changed. The step 0 gain can be changed using  $R'_{GP}$  as shown in figure 13. Also,  $R'_{GP}$  can be switched using the tape selector, as shown in figure 15. However, it is necessary to take into account that the value of  $R_{ADJ}$ , which sets the step 63 gain, is also used for the output bias. When the load resistance on pin 33 is  $R_L$ , the following formula gives the output bias,  $V_{BMAX}$ .

$$V_{BMAX} = 2.4 \times R_L / R_{ADJ}$$

Therefore, it is possible to compensate the output bias,  $V_{BMAX}$  for the  $R_{ADJ}$  setting by changing  $R_L$ .

Note:  $R_{ADJ}$  should be in the range 16 k to 75 k .

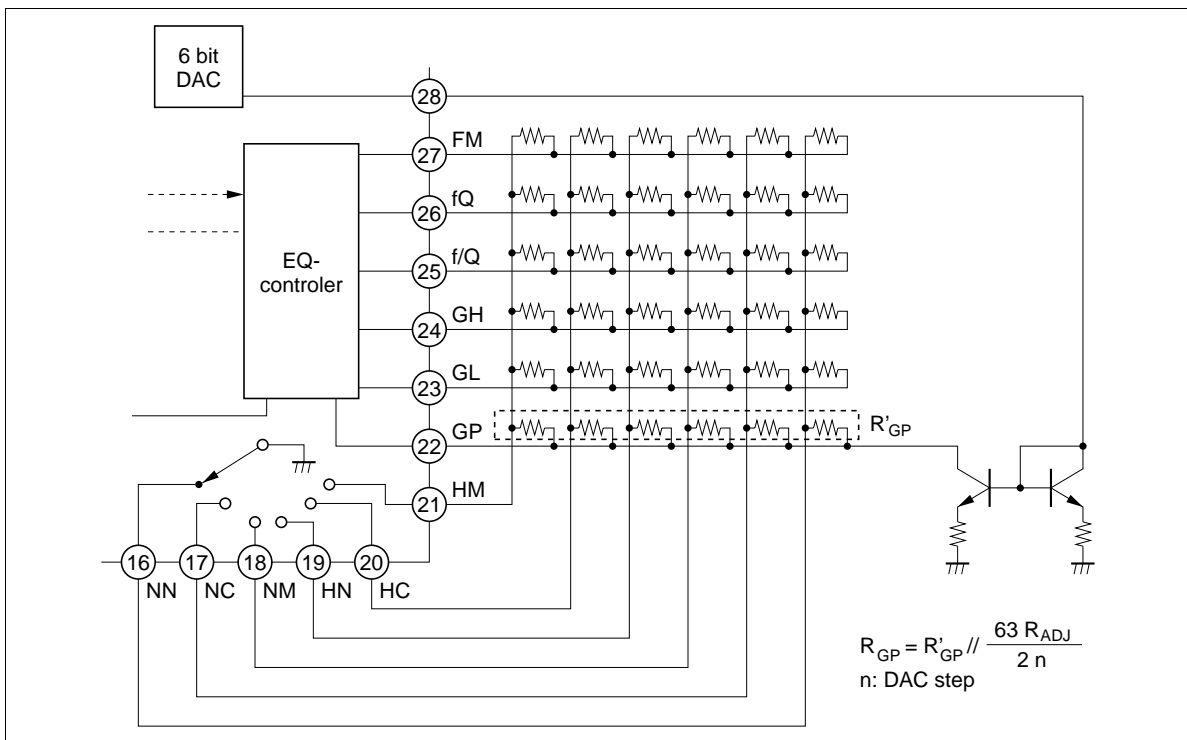

**Figure 15 Switch by Tape Select**

# HA12167FB/HA12169FB

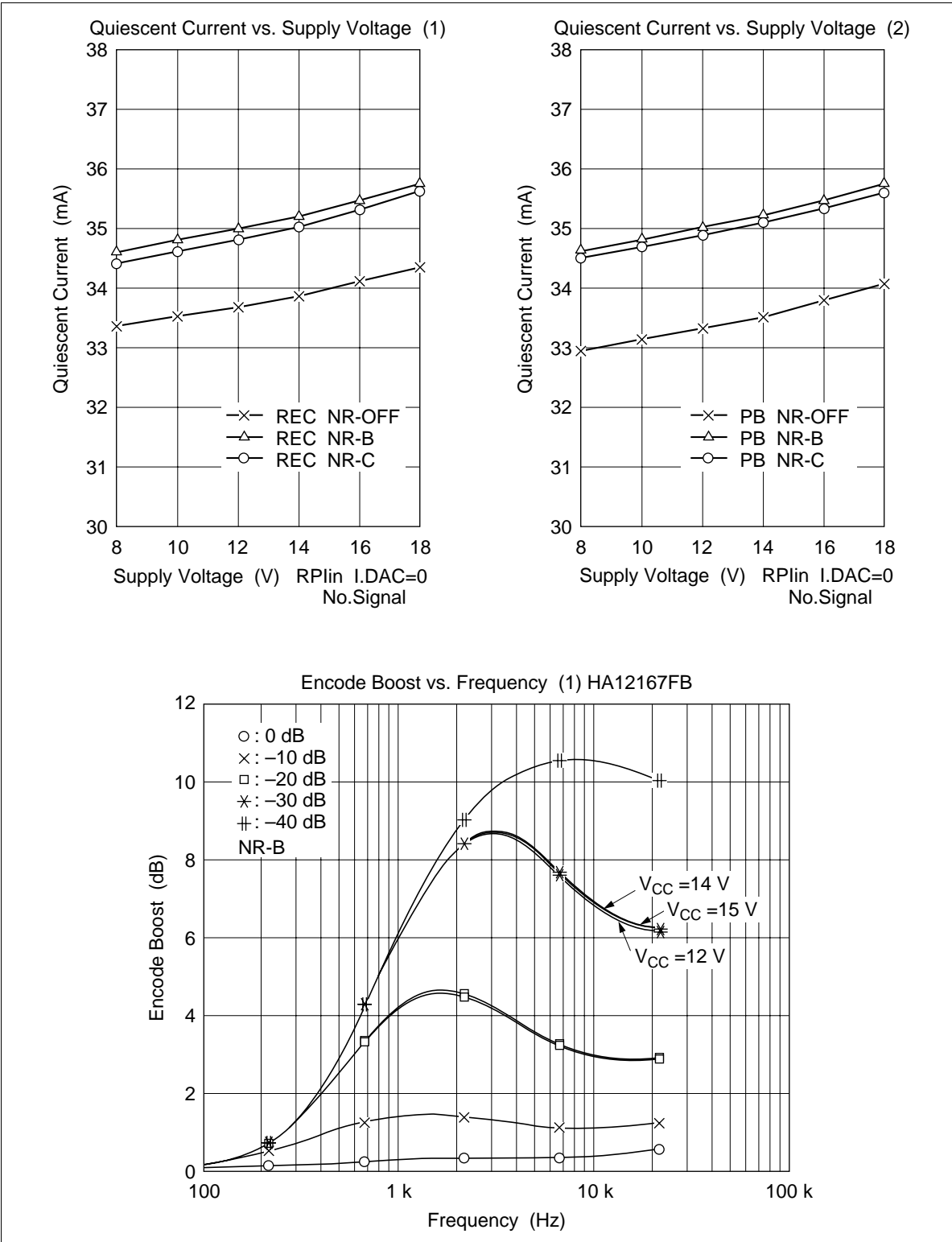

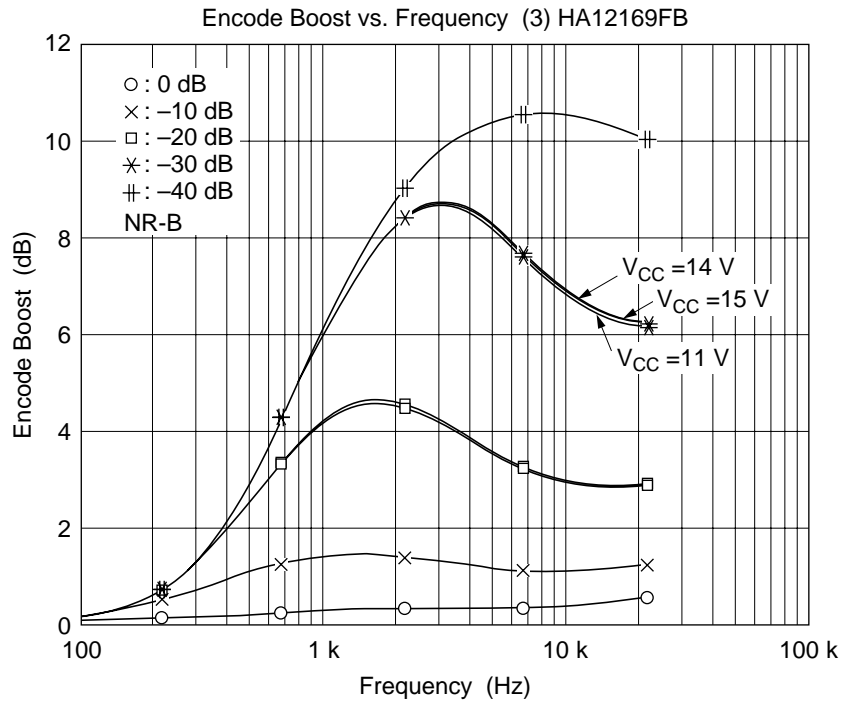
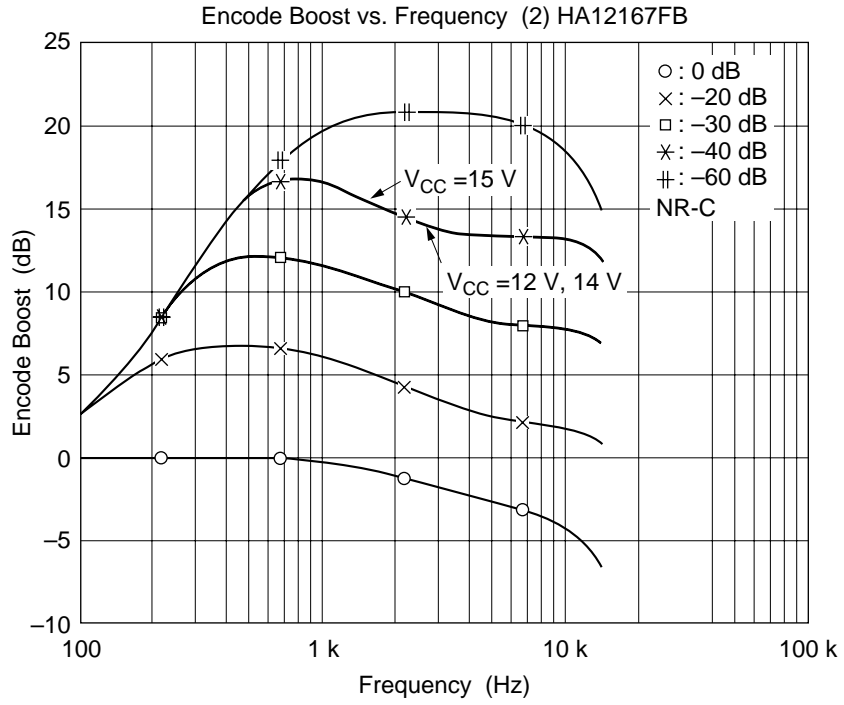

# HA12167FB/HA12169FB

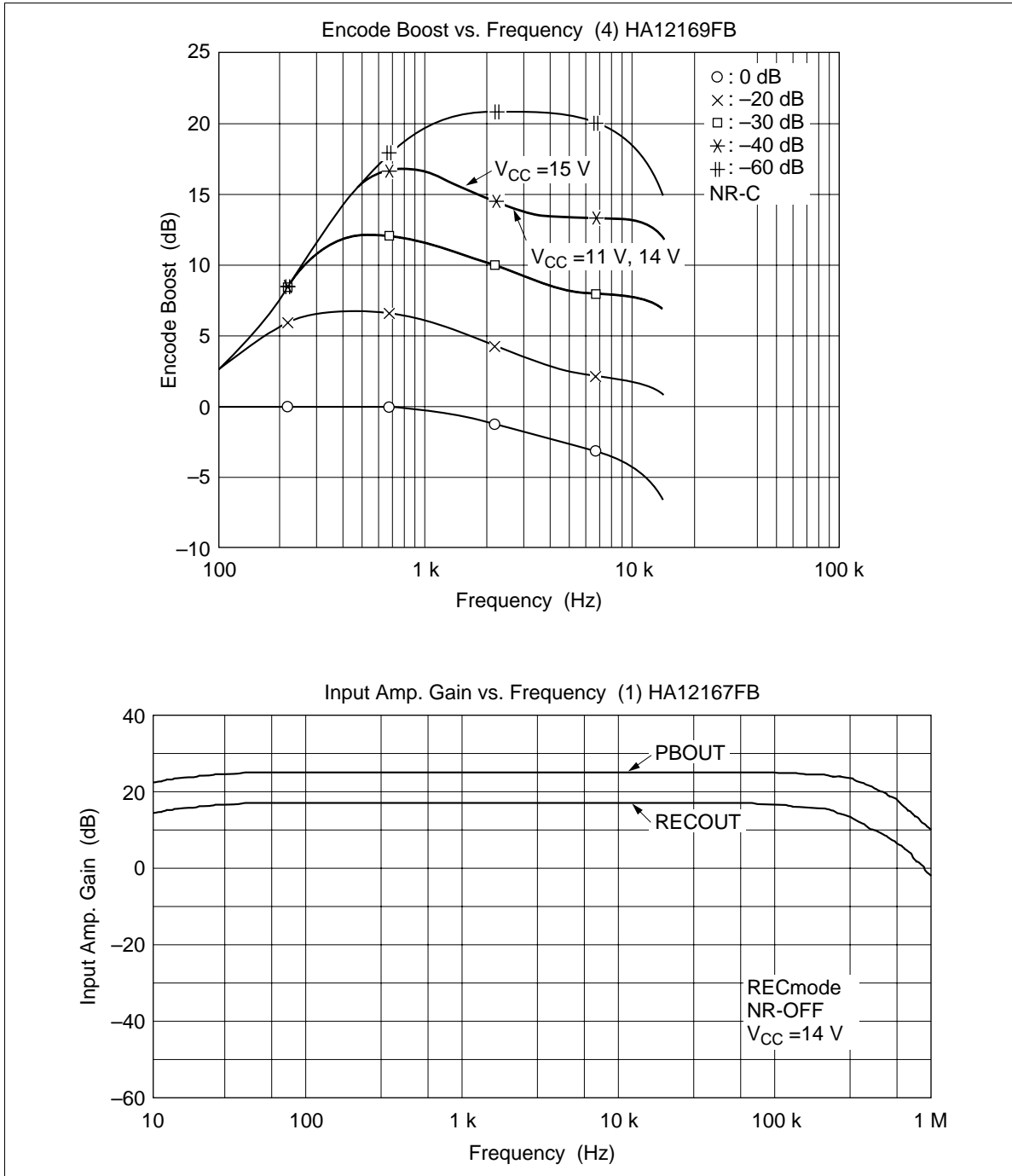

# HA12167FB/HA12169FB

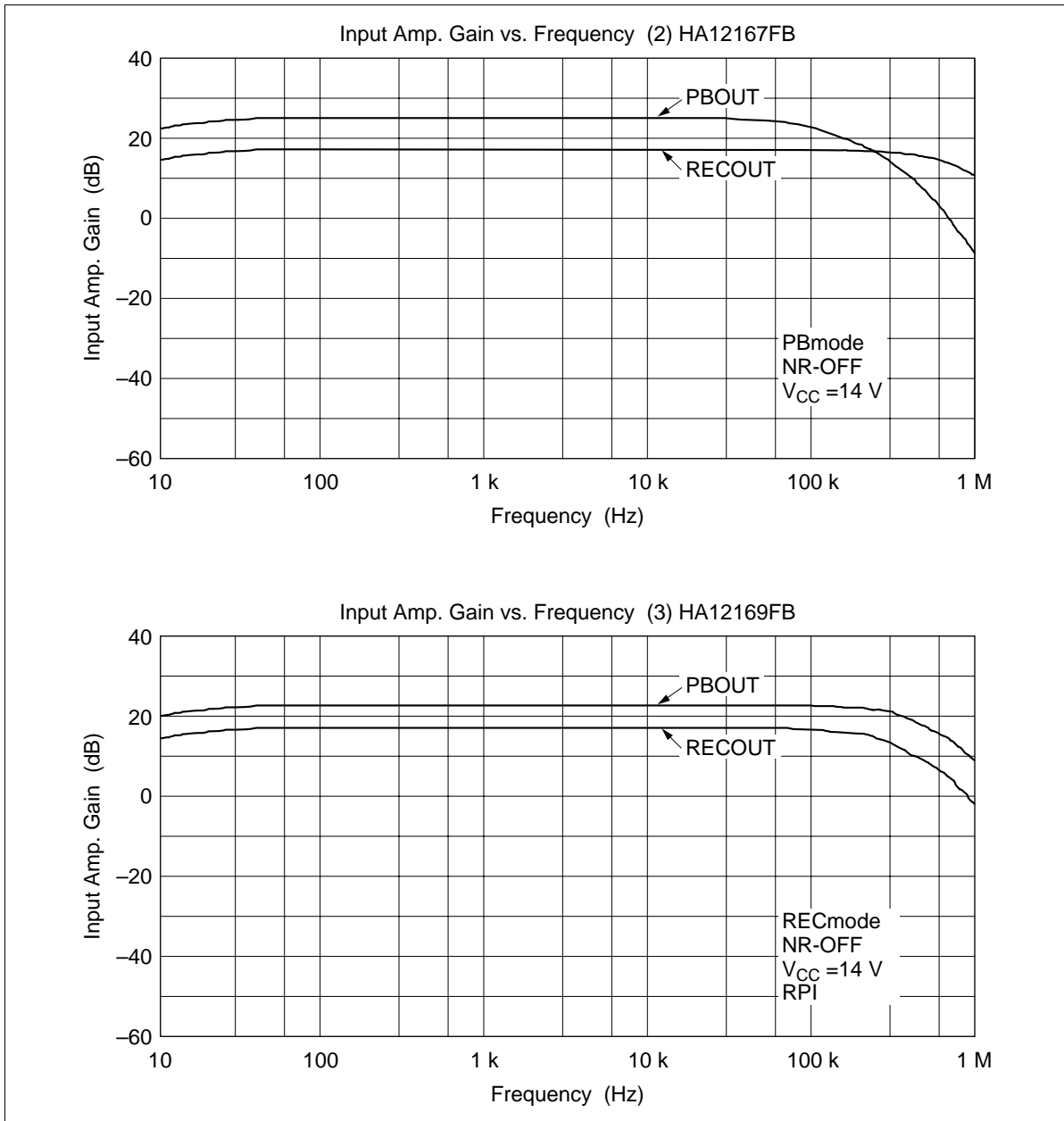

## HA12167FB/HA12169FB

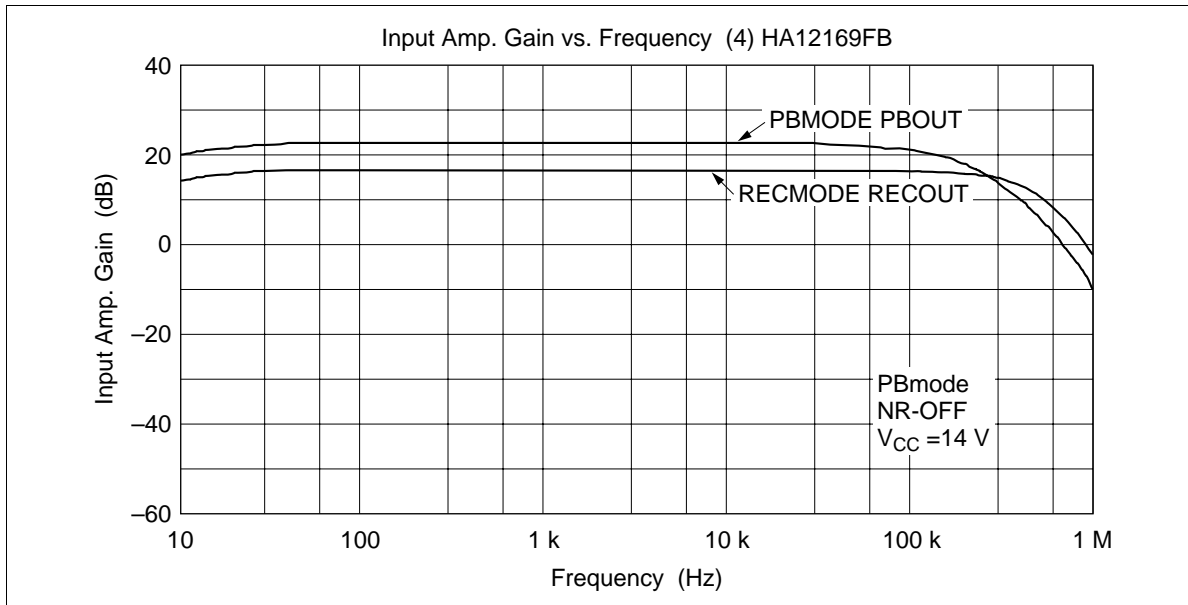

HITACHI



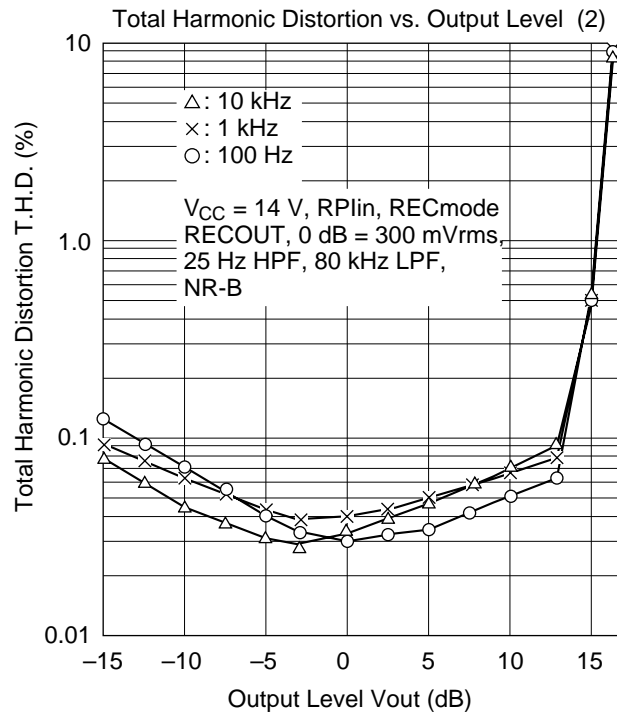
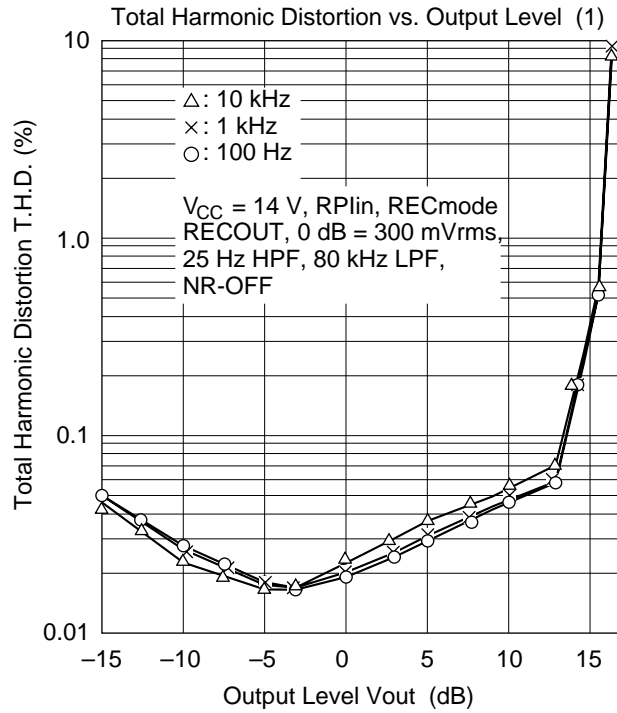

# HA12167FB/HA12169FB

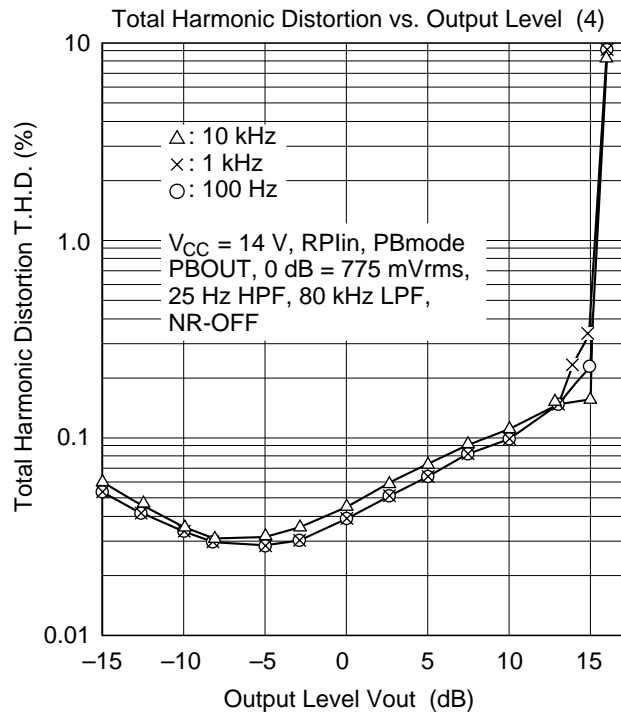
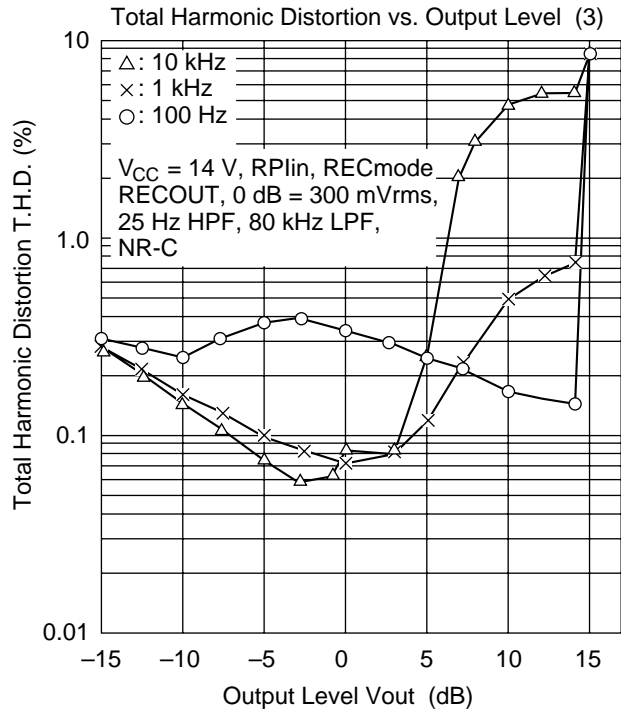

HITACHI

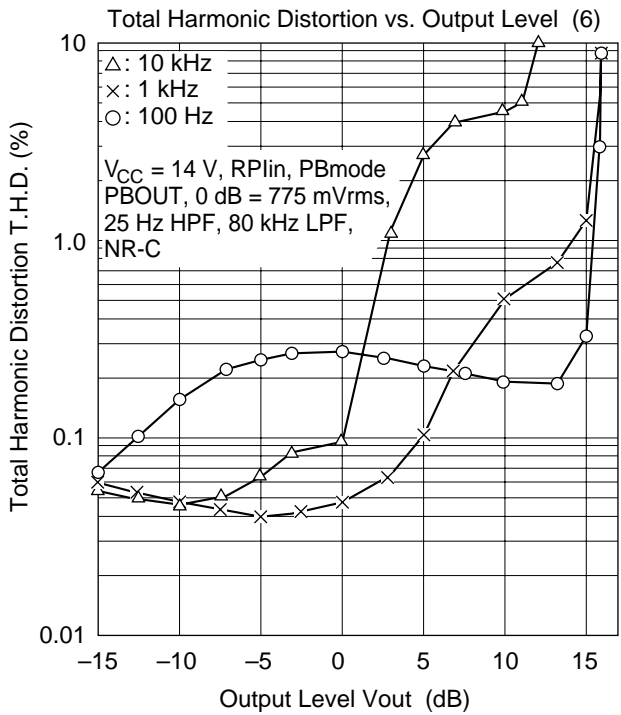
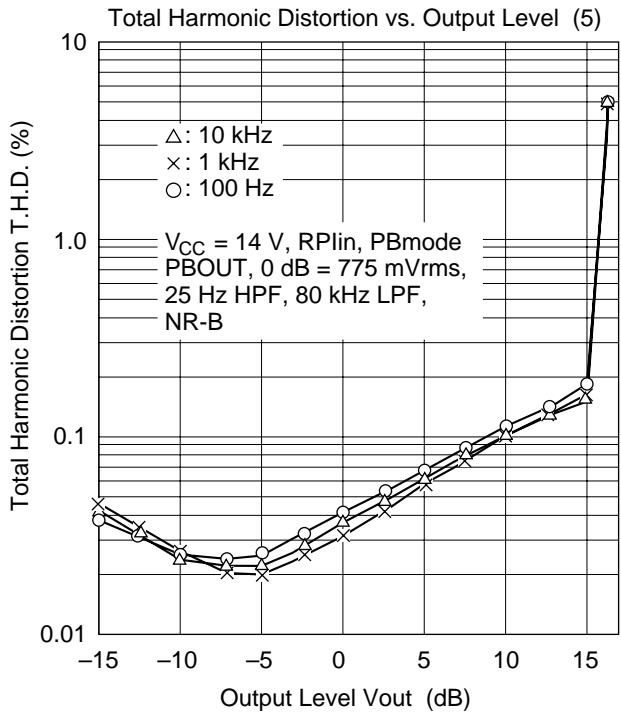

# HA12167FB/HA12169FB

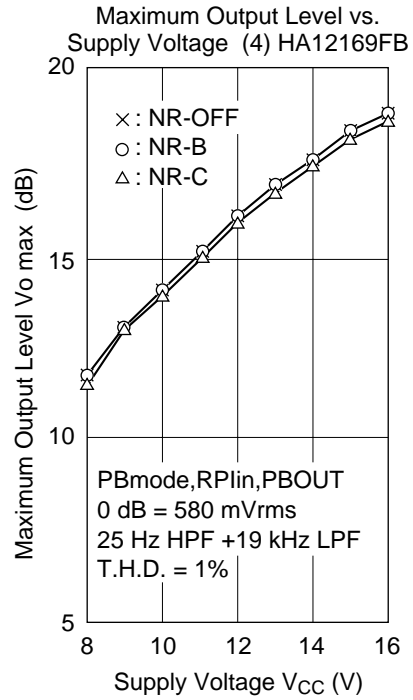
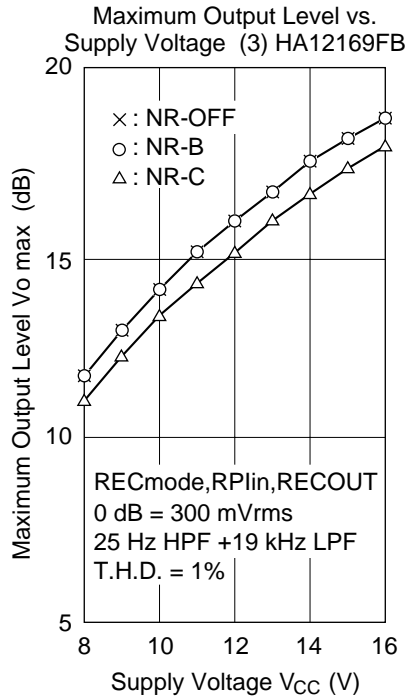
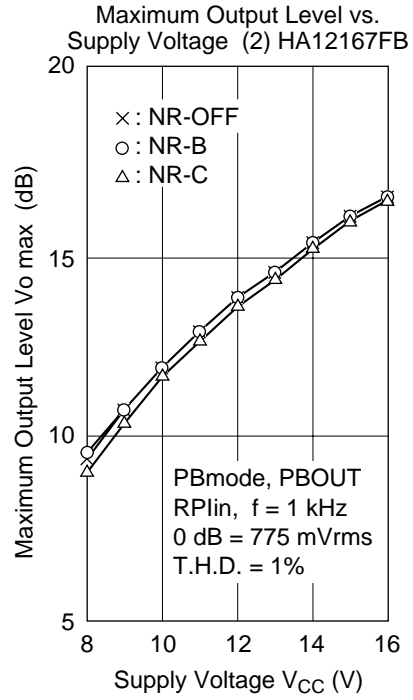
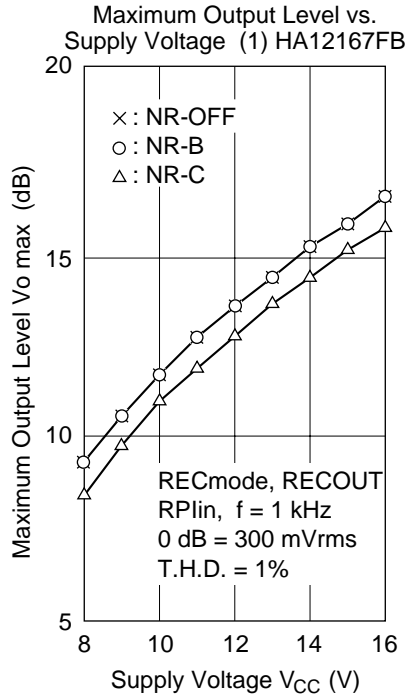

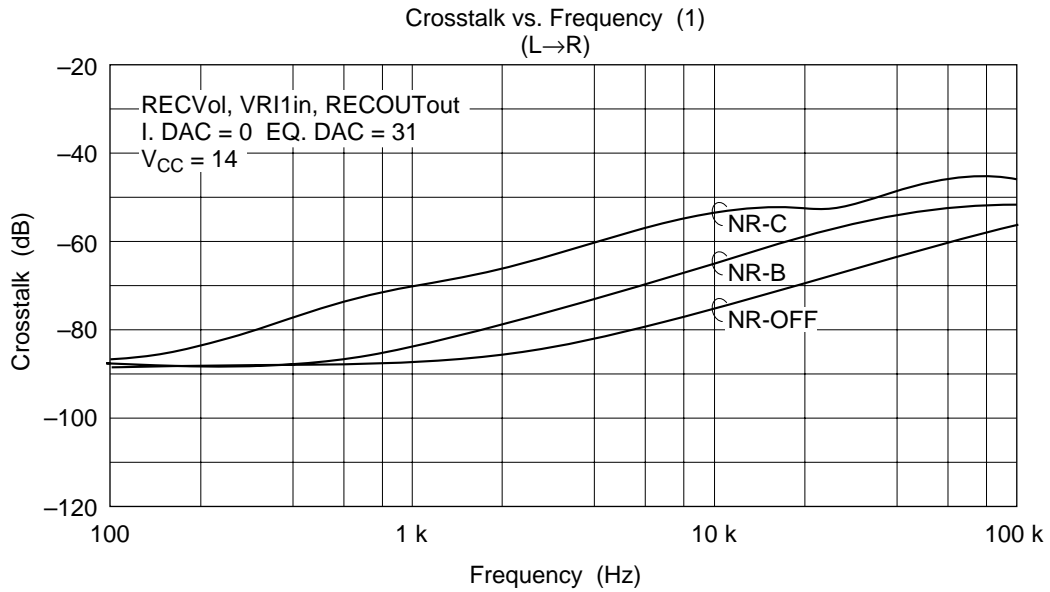
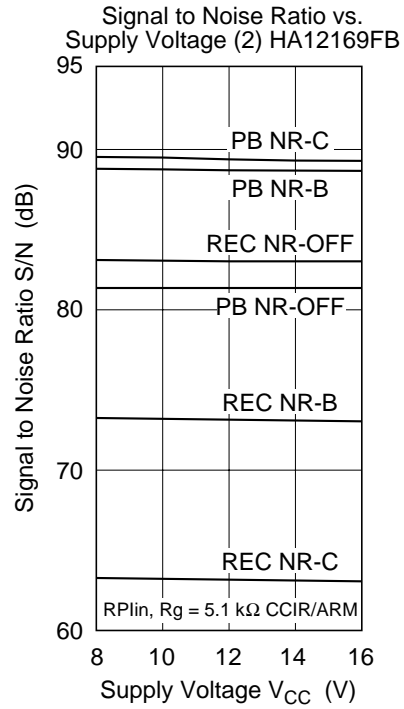
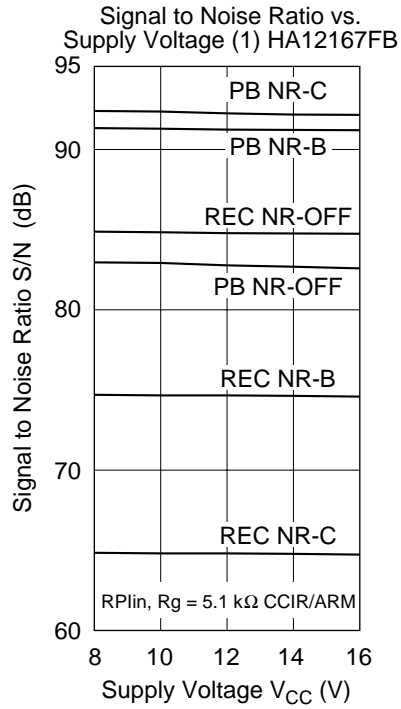

# HA12167FB/HA12169FB

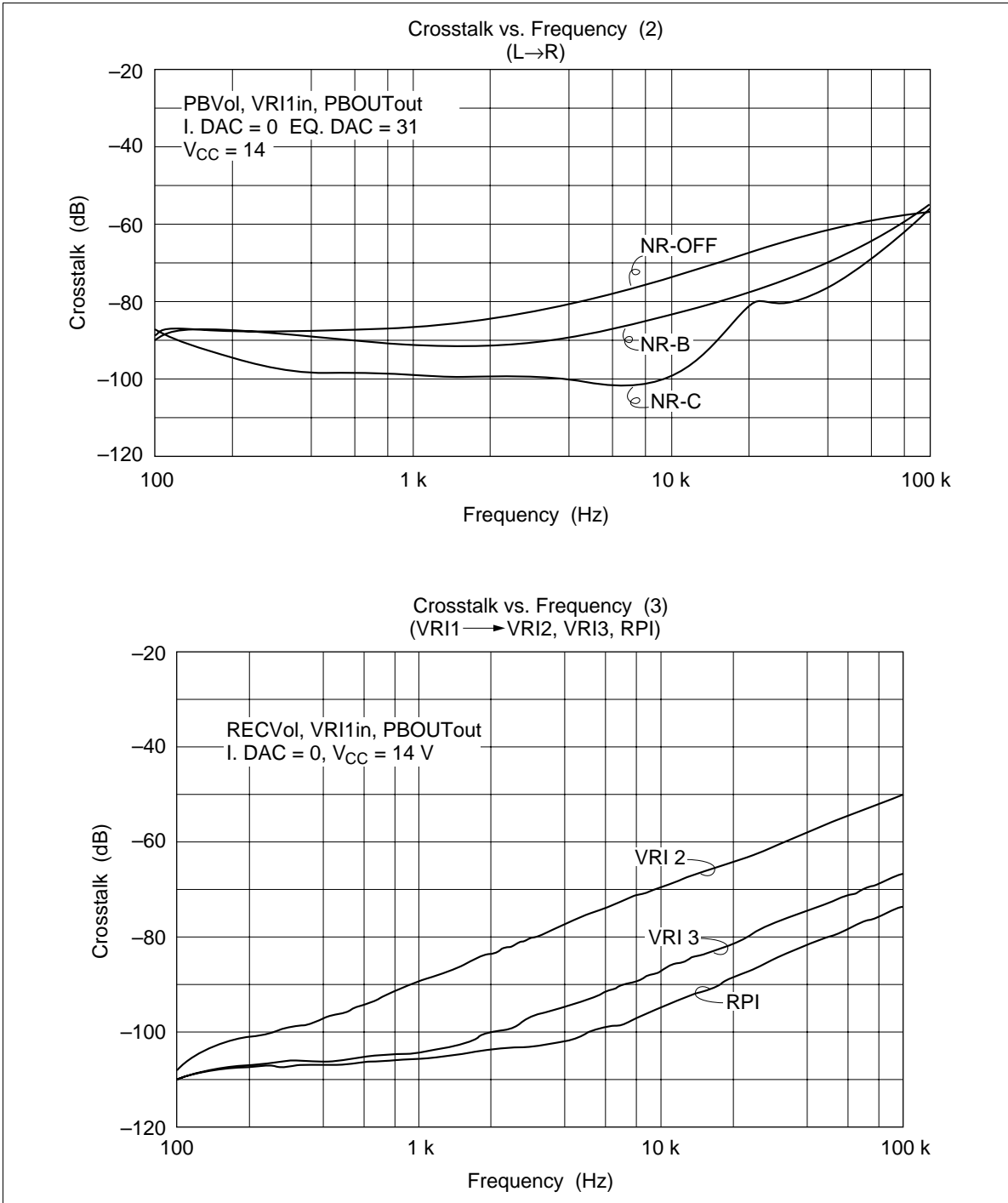

**HITACHI**

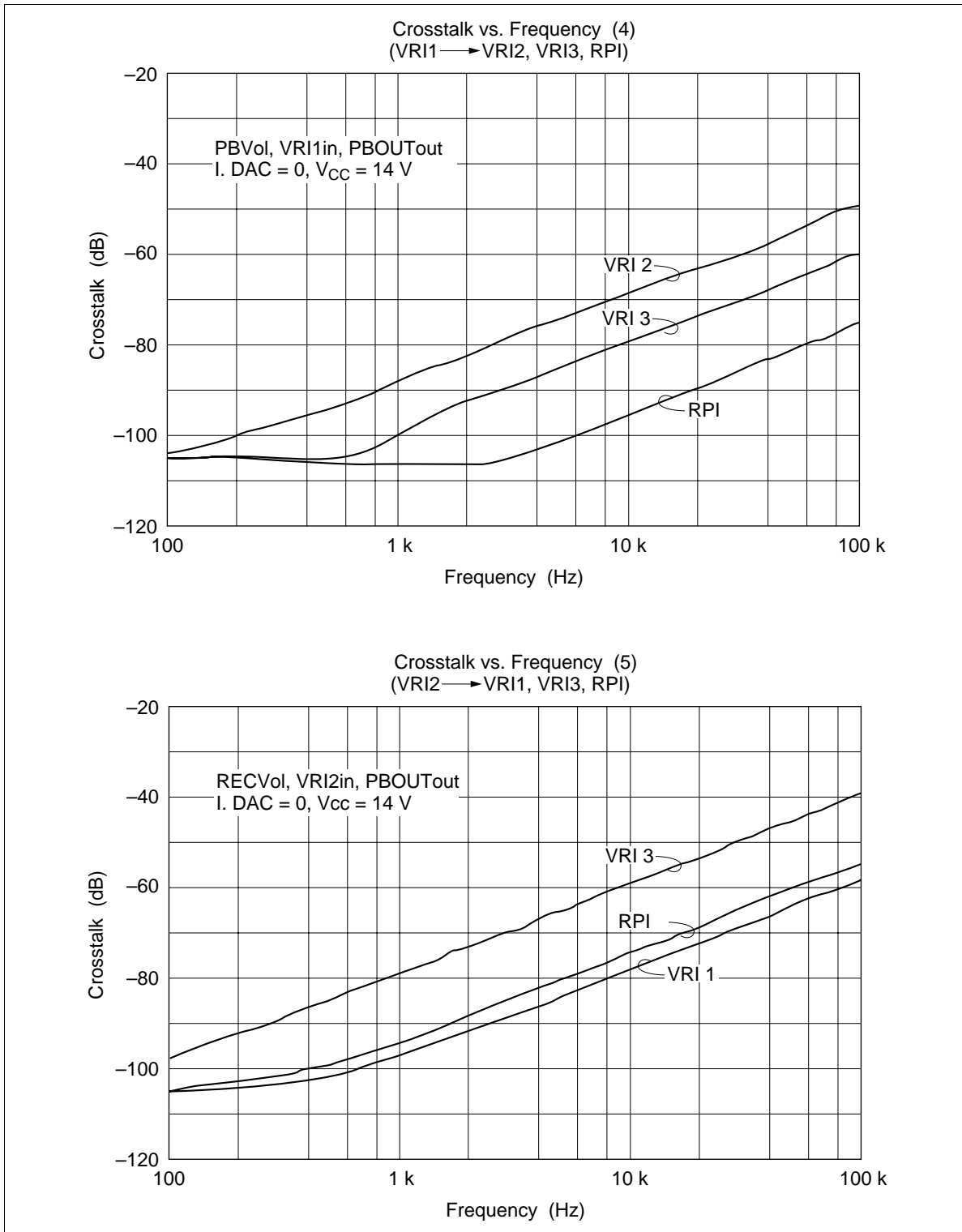

# HA12167FB/HA12169FB

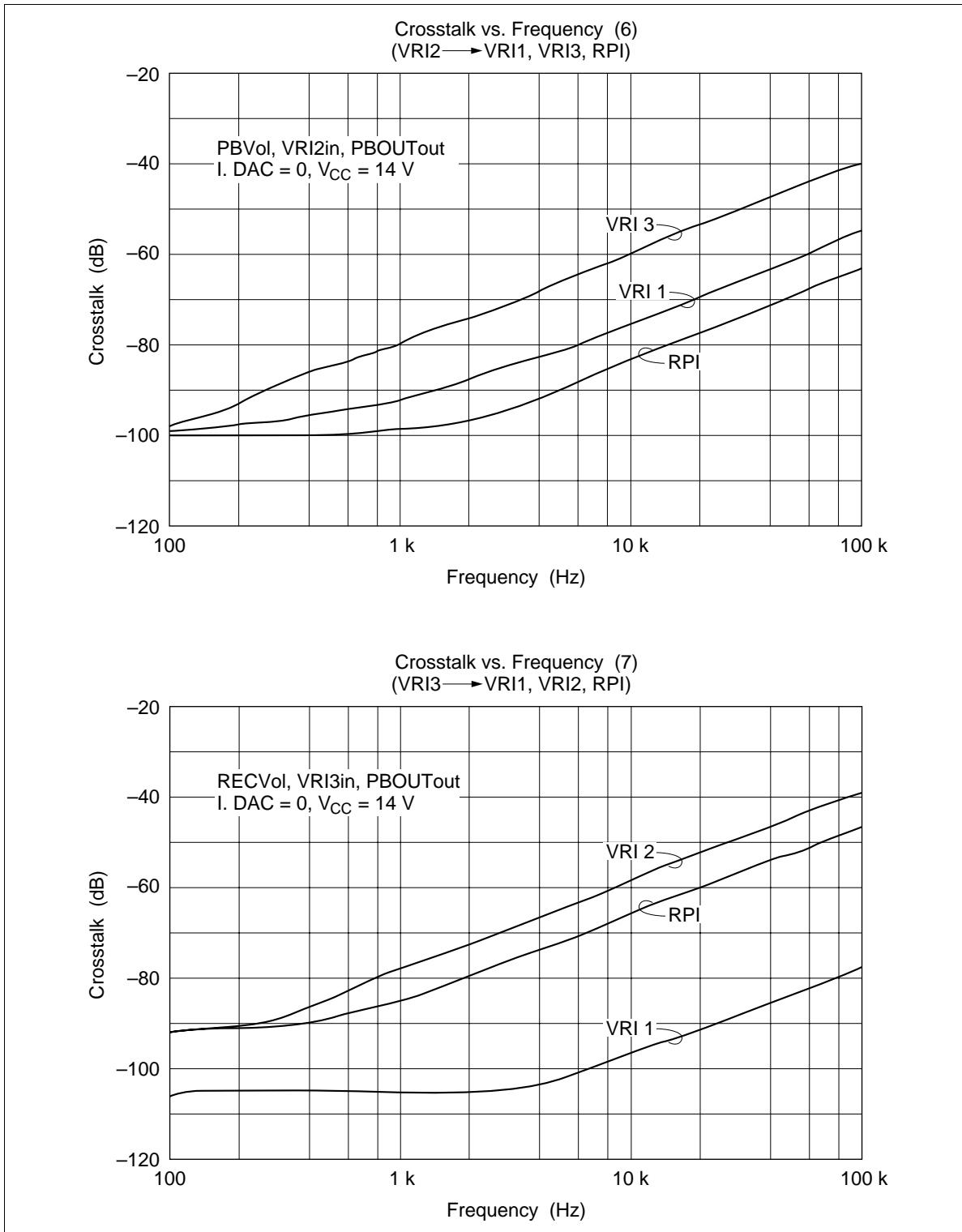

**HITACHI**



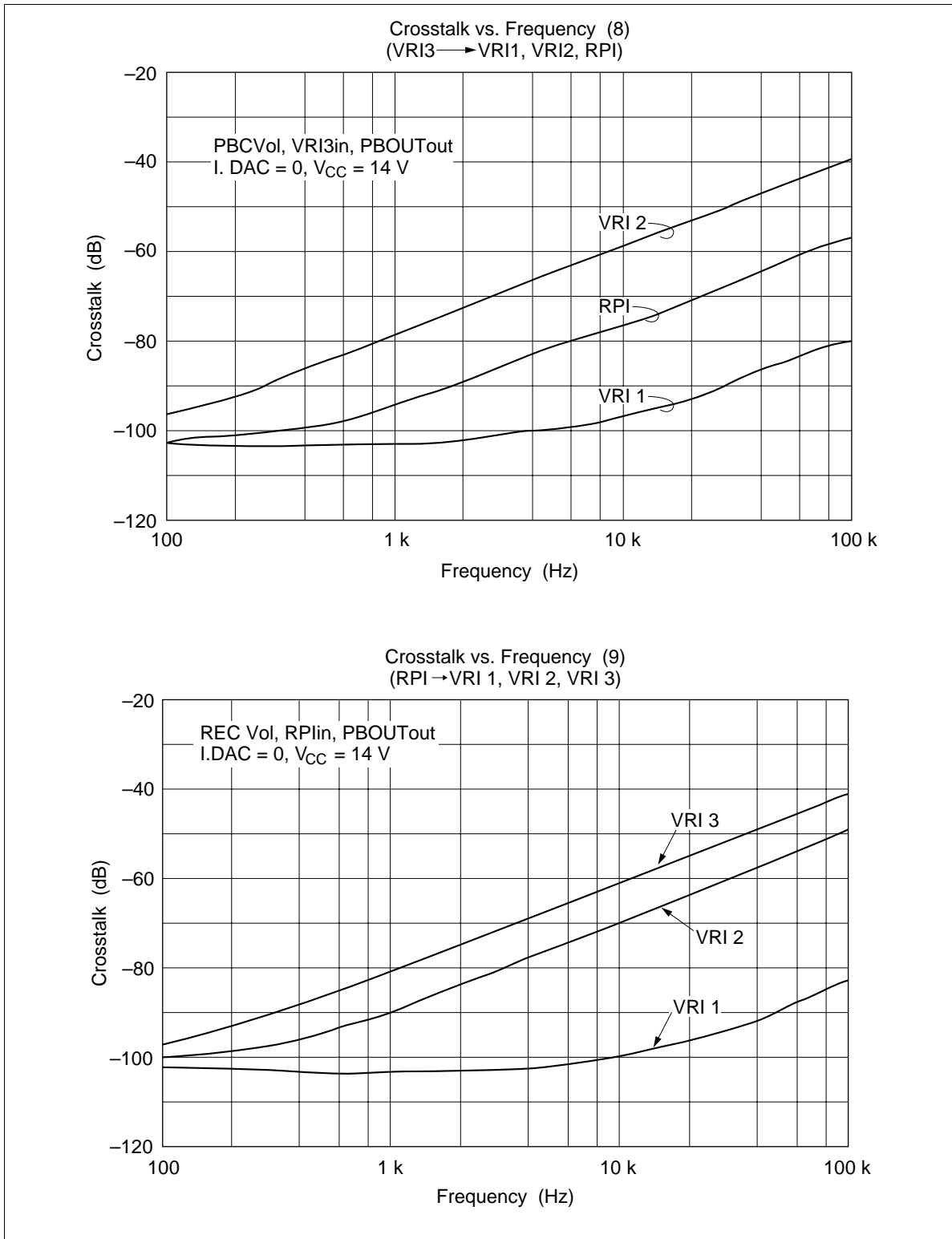

# HA12167FB/HA12169FB

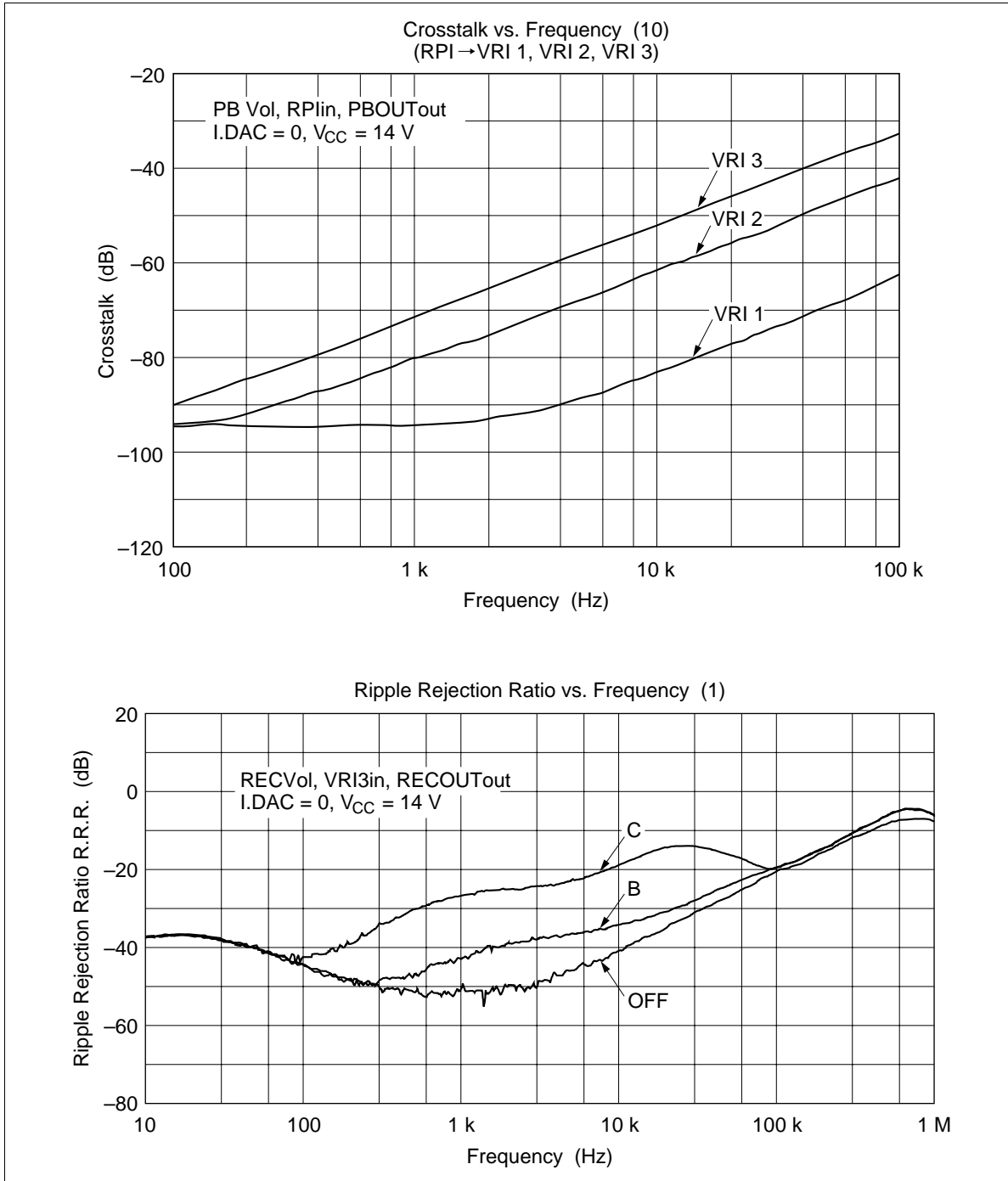

HITACHI

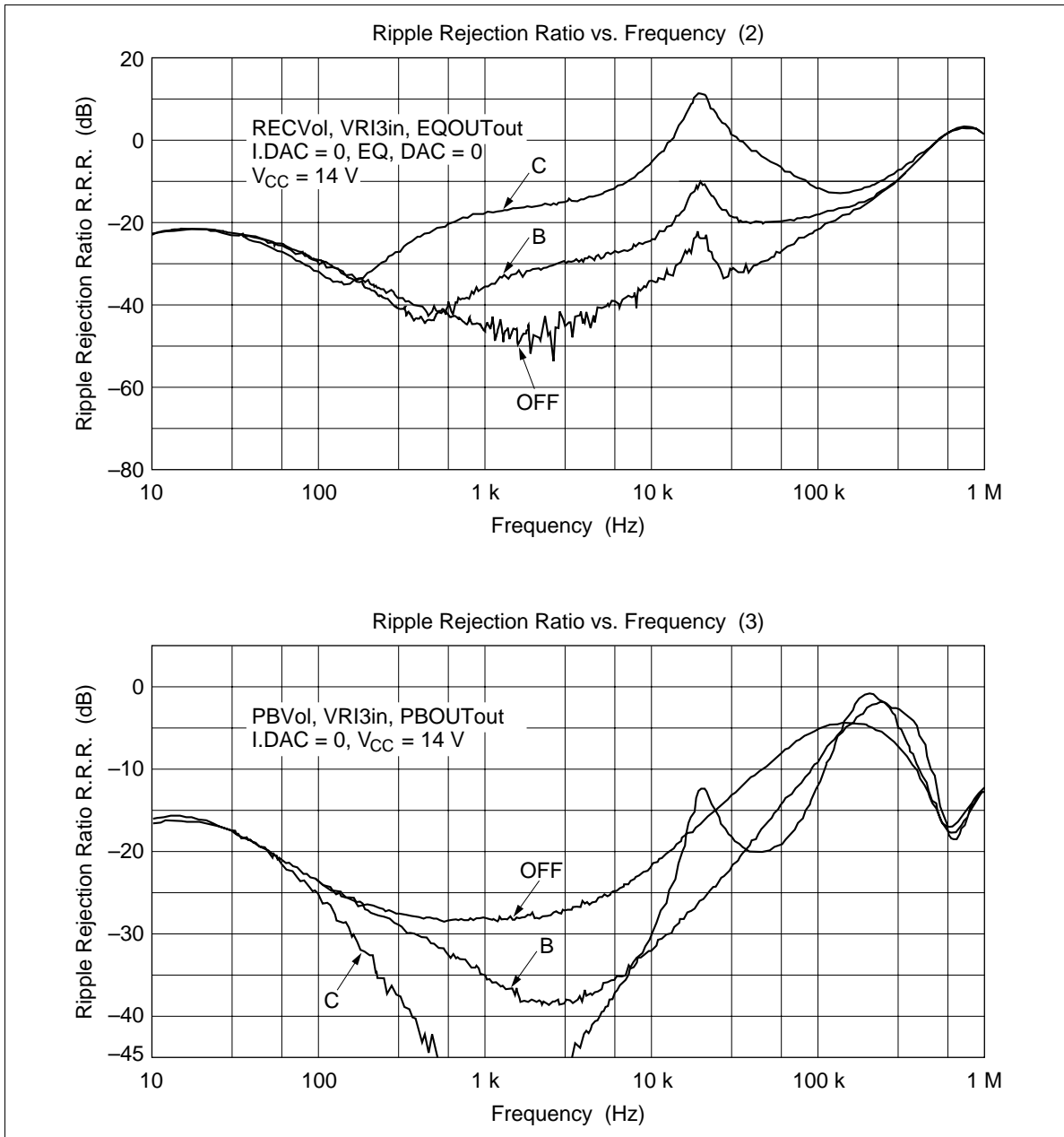

# HA12167FB/HA12169FB

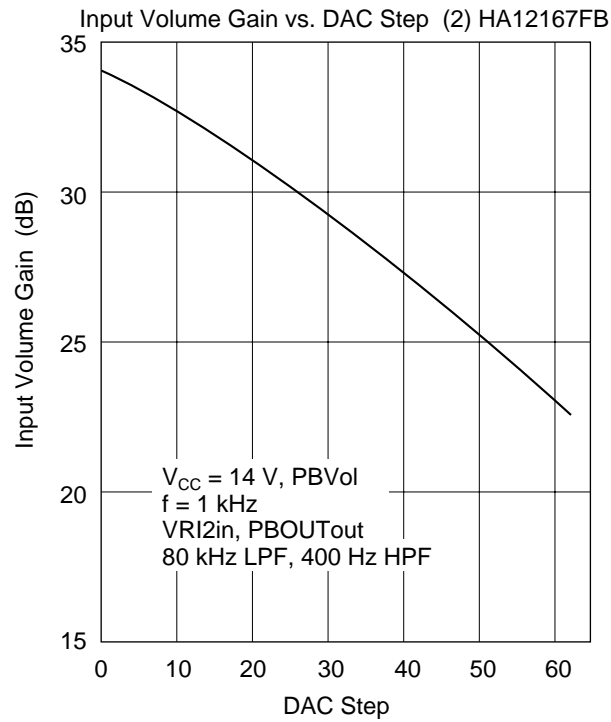
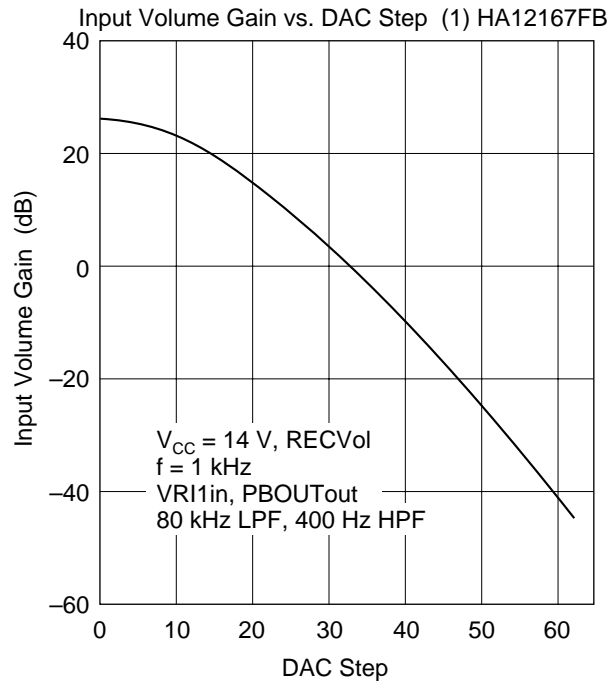

HITACHI

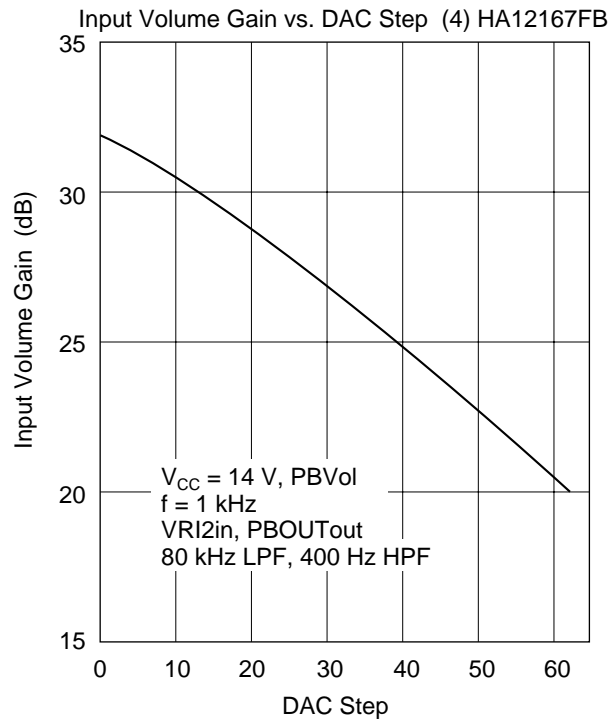
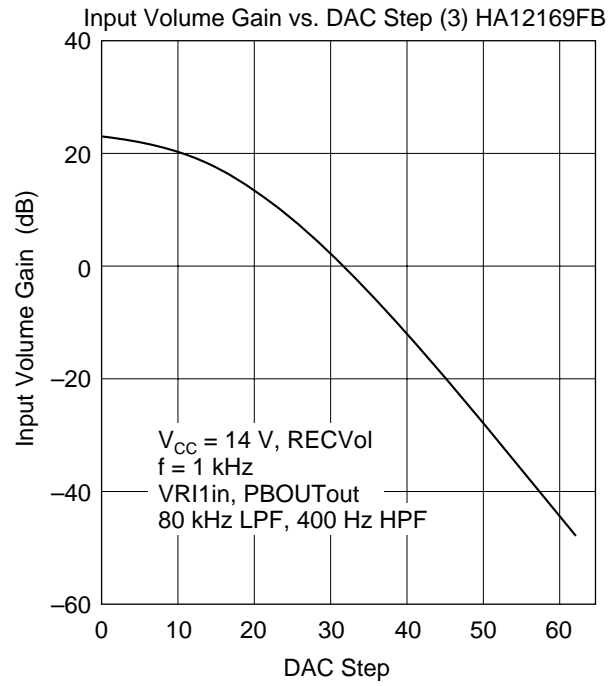

# HA12167FB/HA12169FB

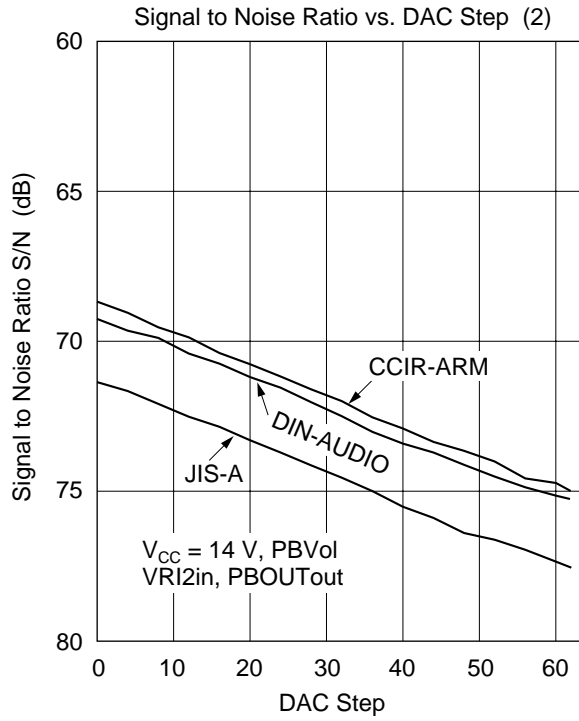
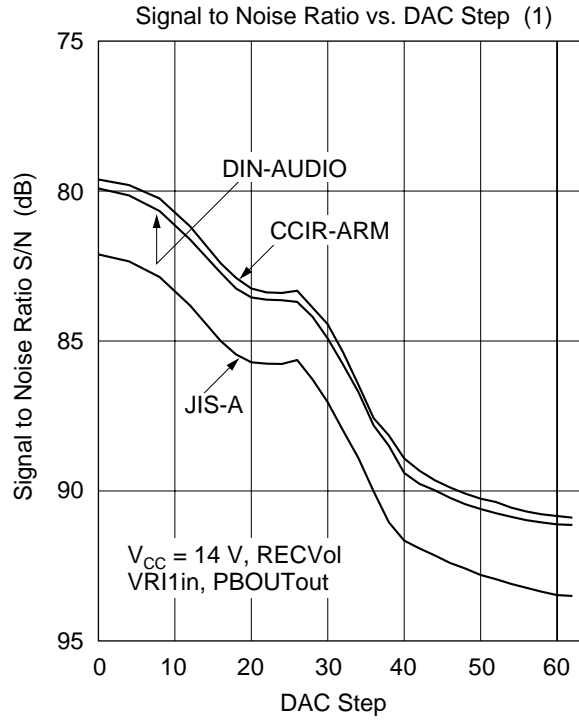

HITACHI

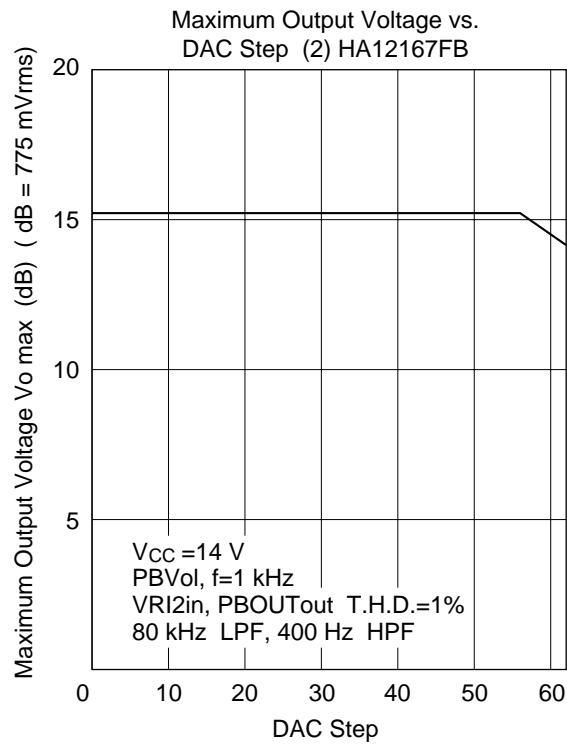
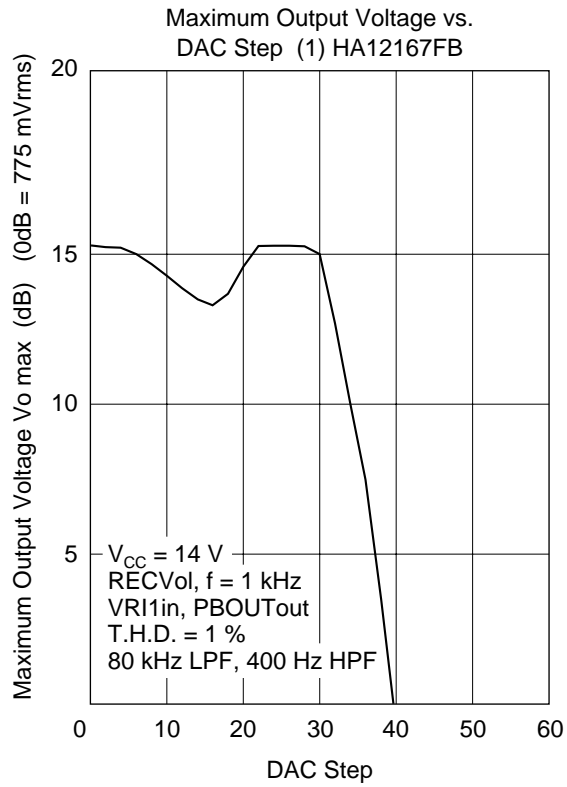

# HA12167FB/HA12169FB

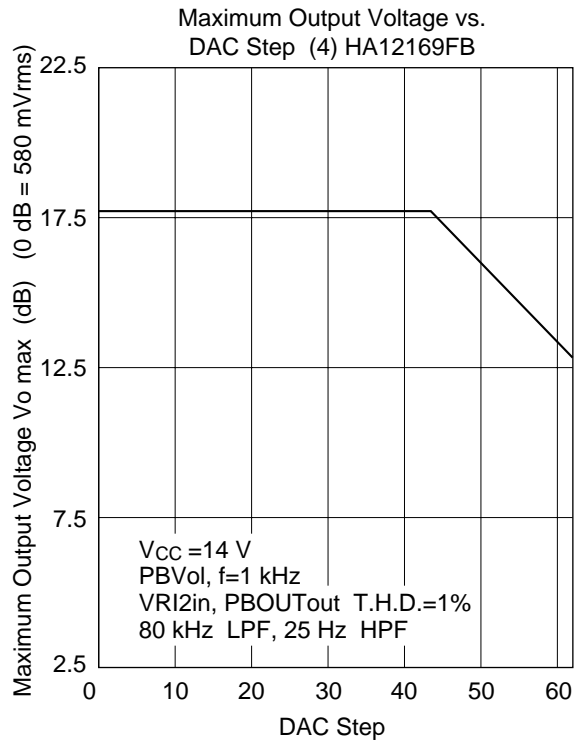
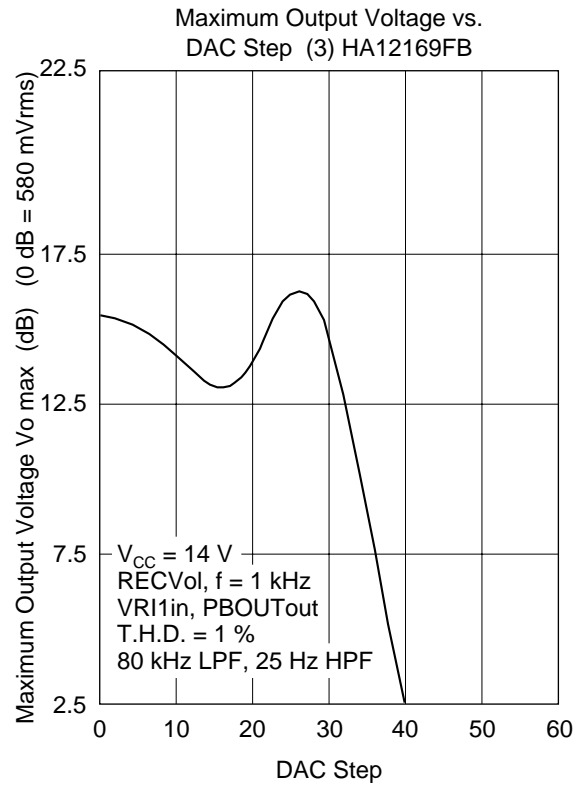

**HITACHI**



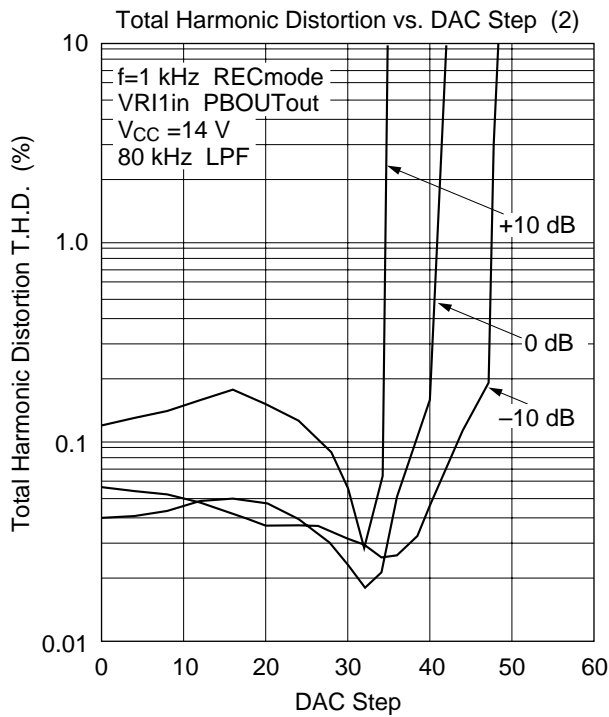
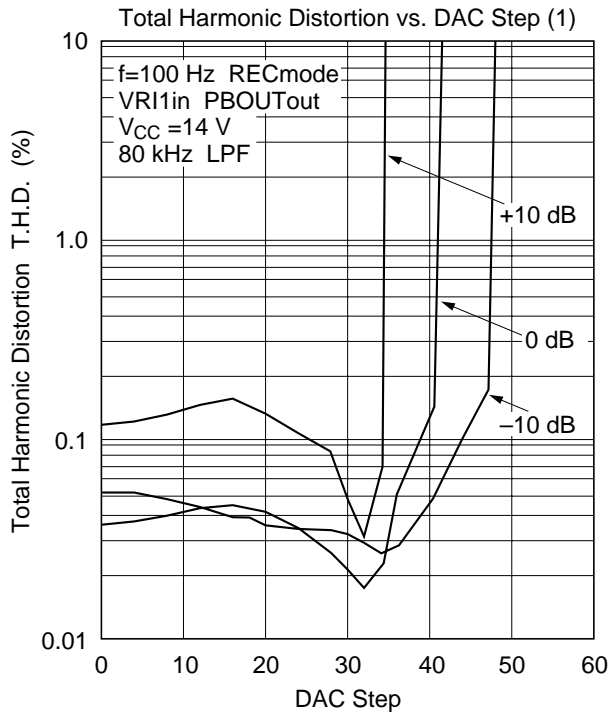

# HA12167FB/HA12169FB

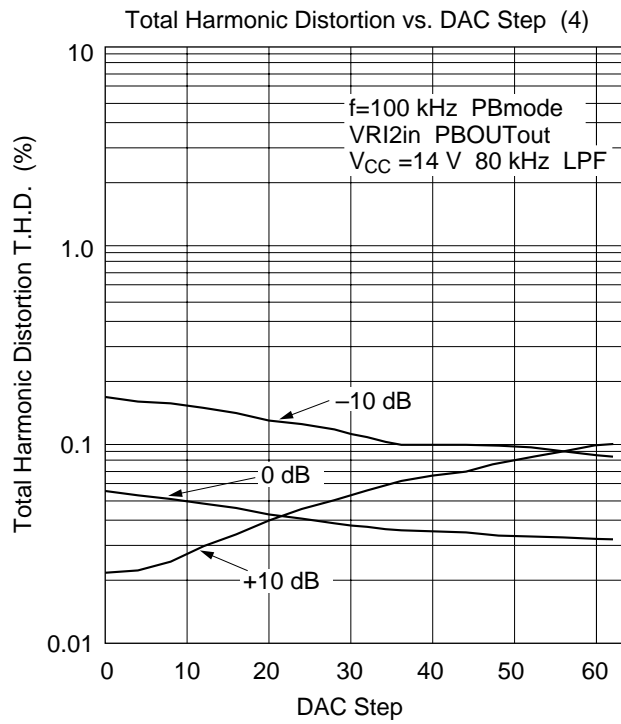
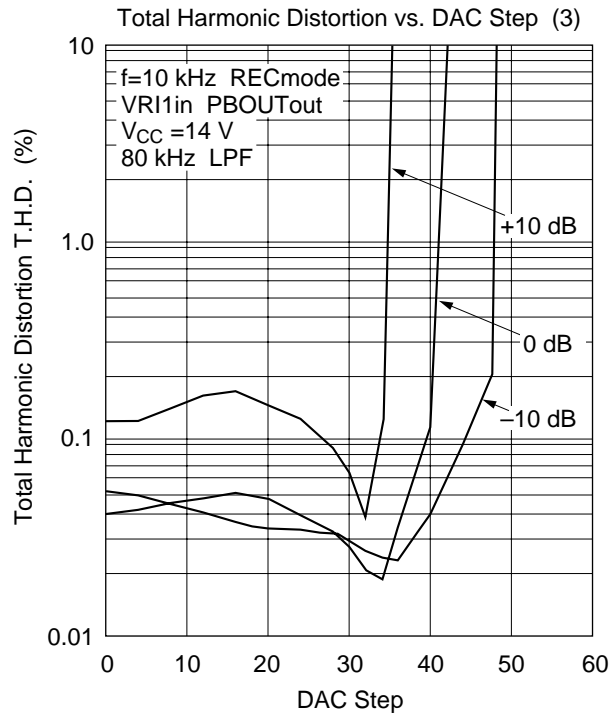

HITACHI

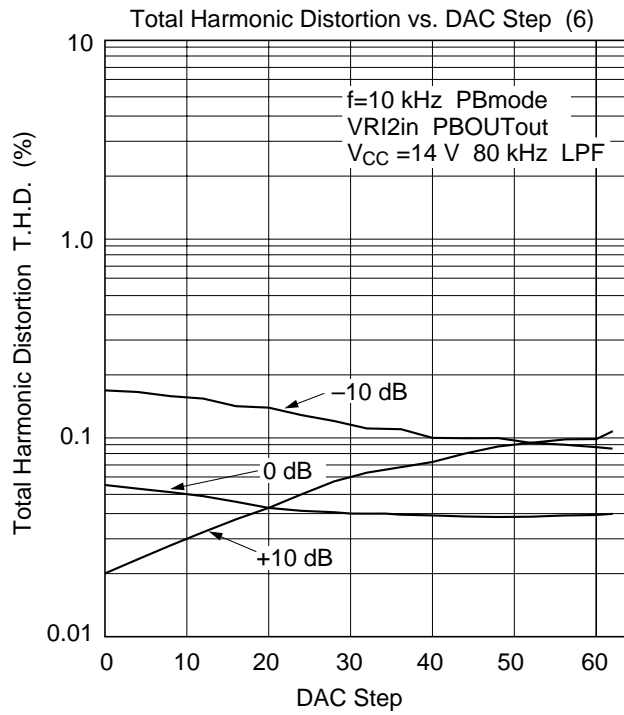
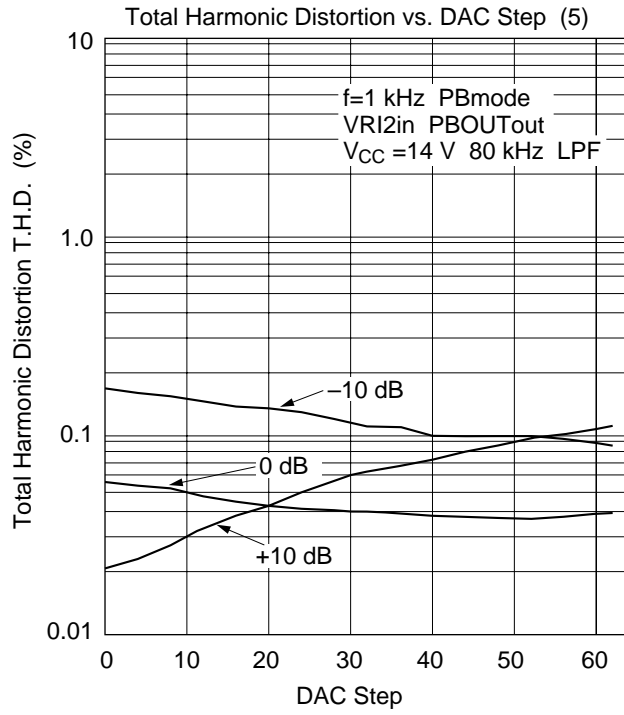

# HA12167FB/HA12169FB

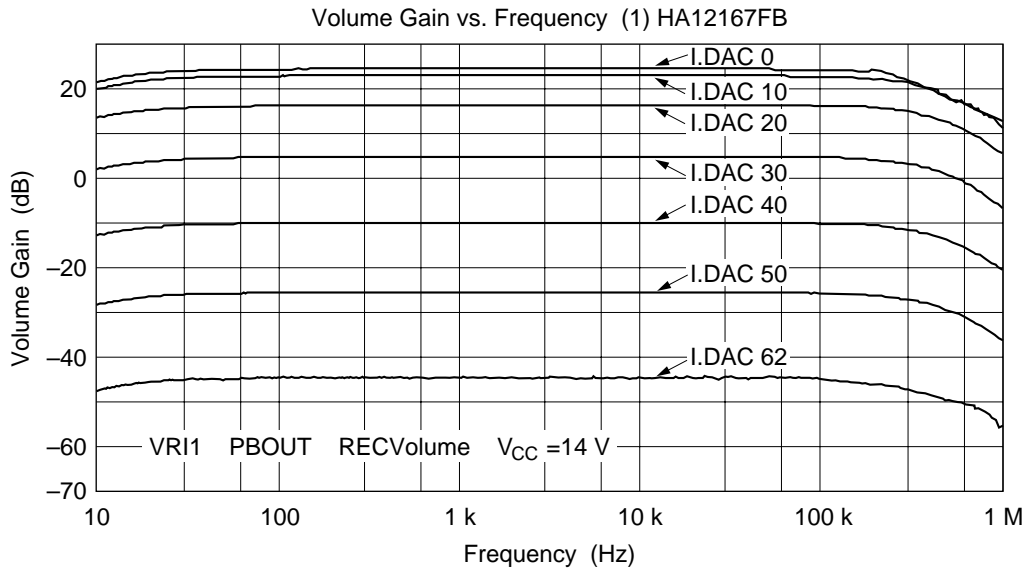
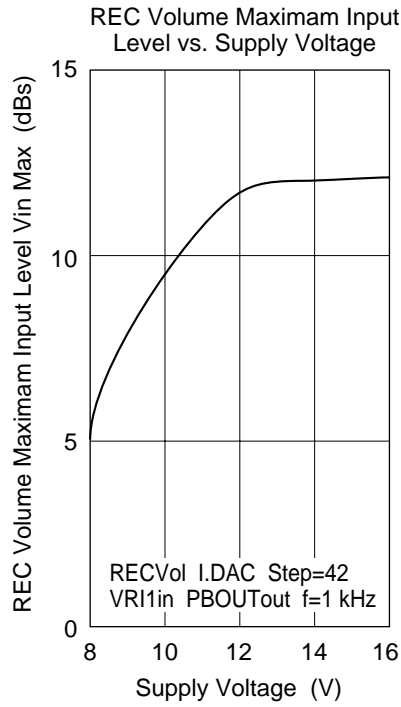

**HITACHI**

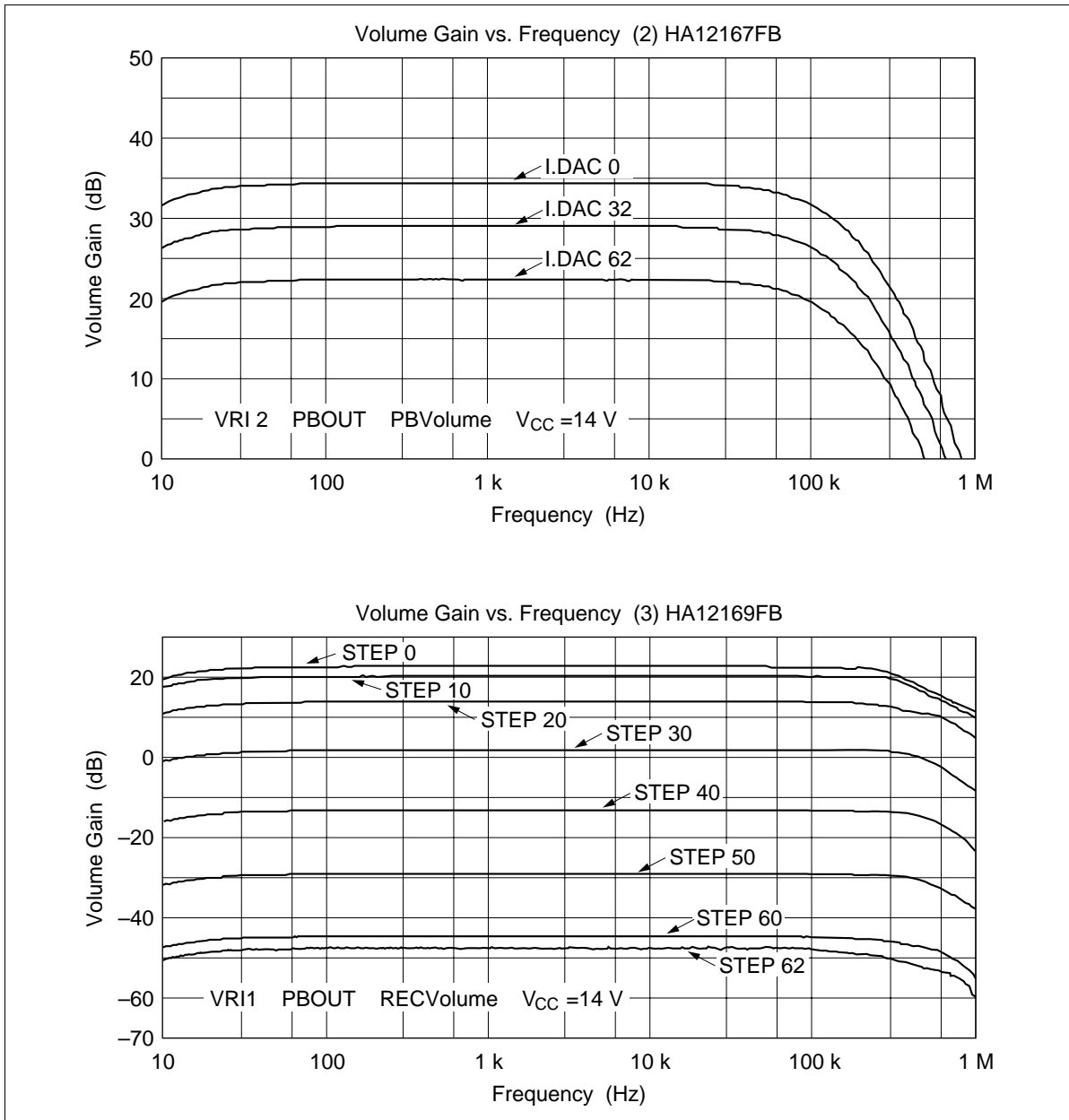

# HA12167FB/HA12169FB

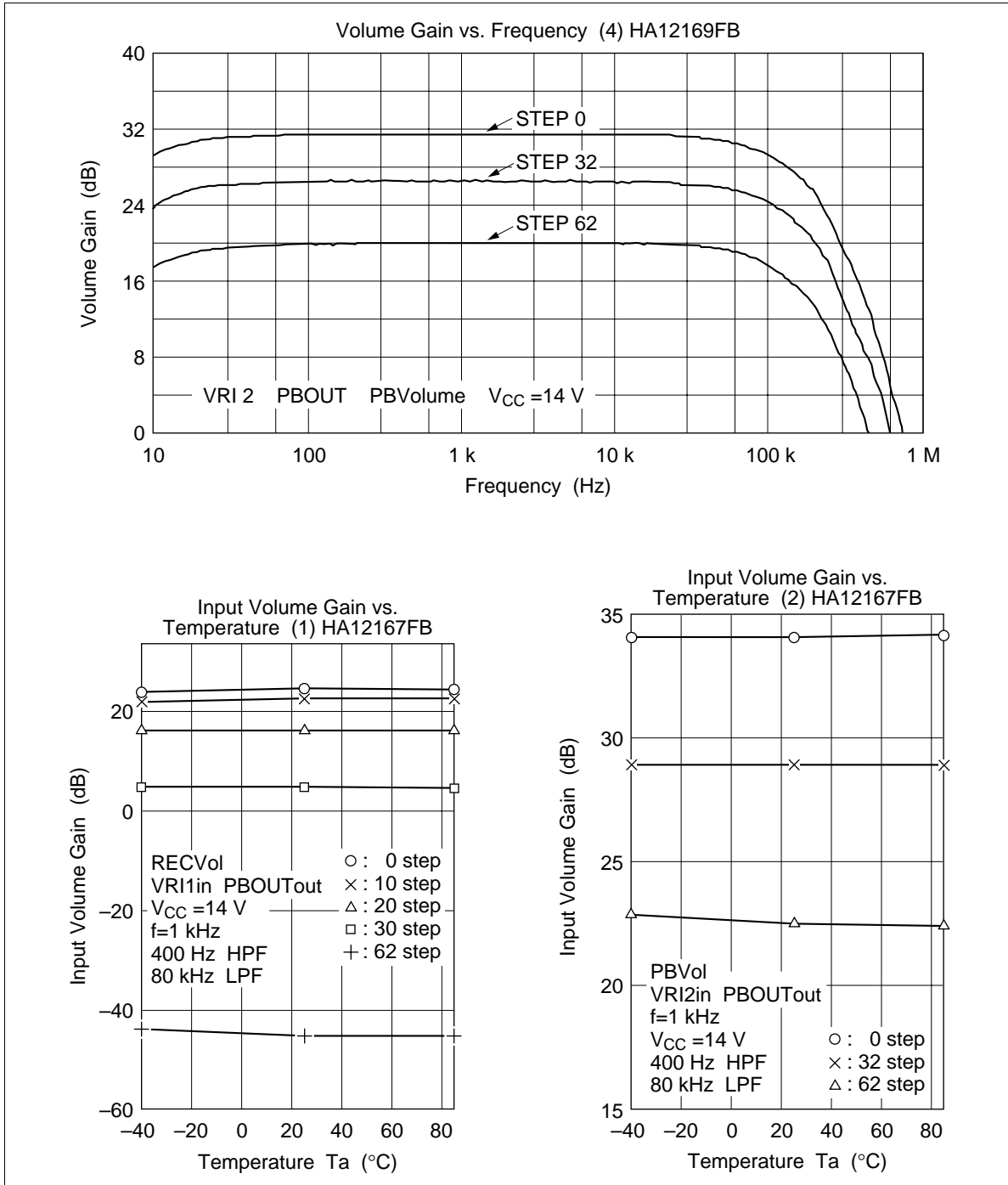

HITACHI

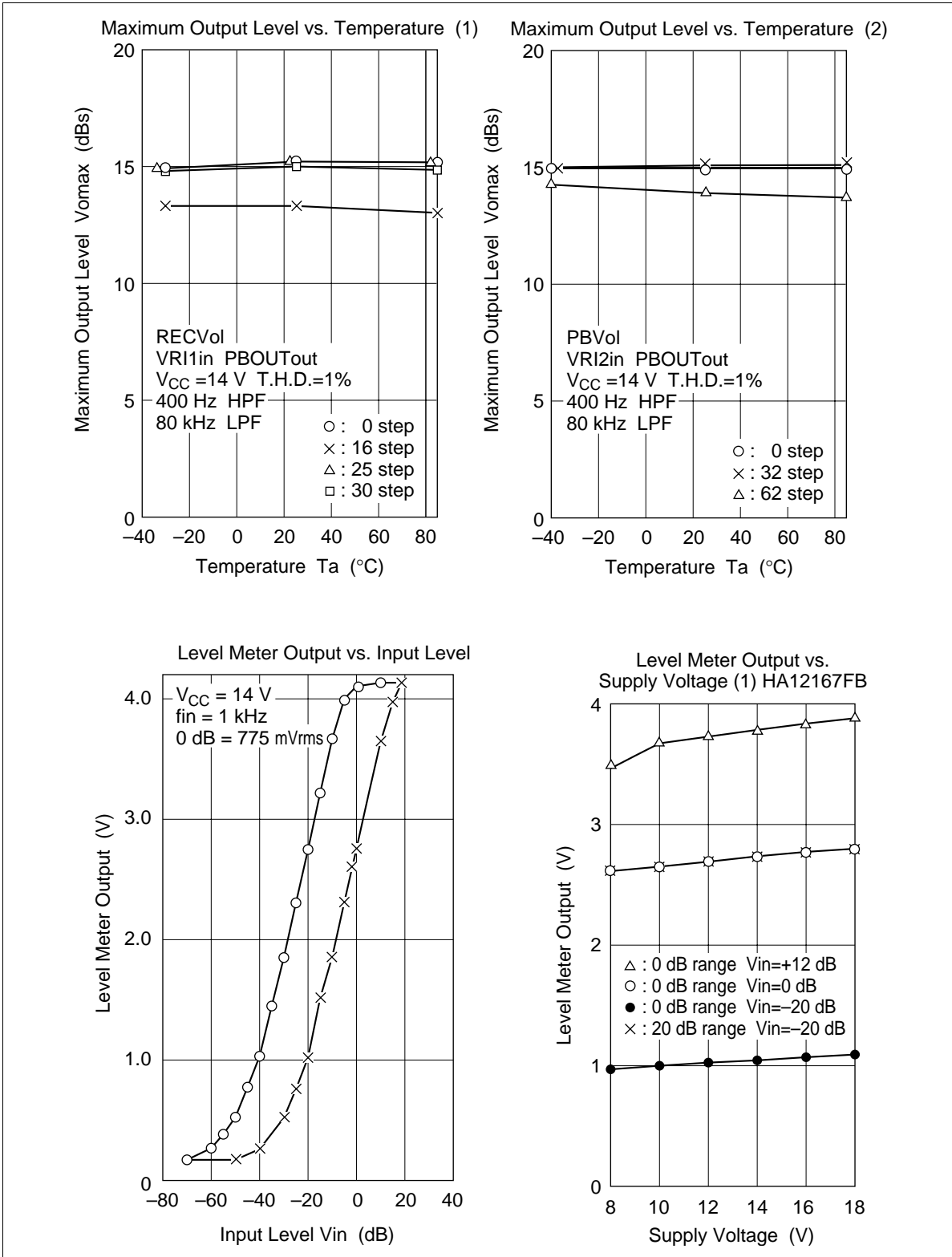

# HA12167FB/HA12169FB

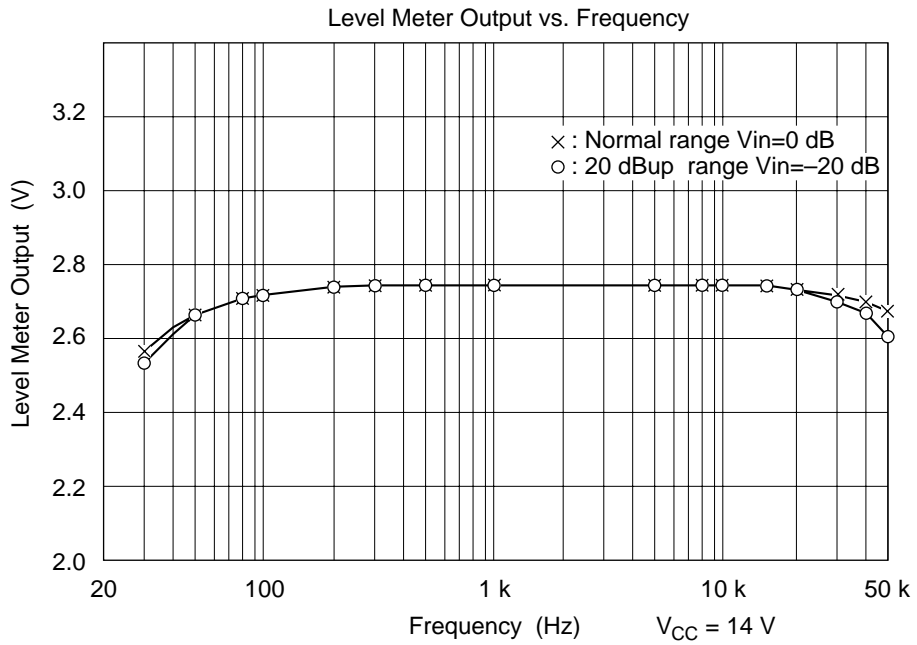
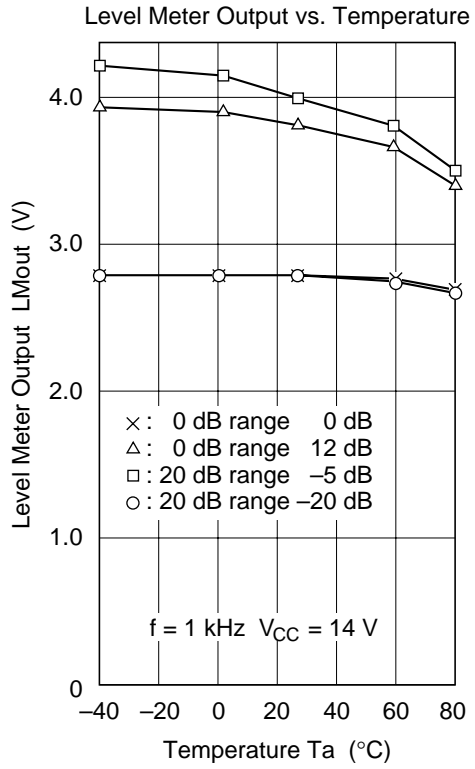
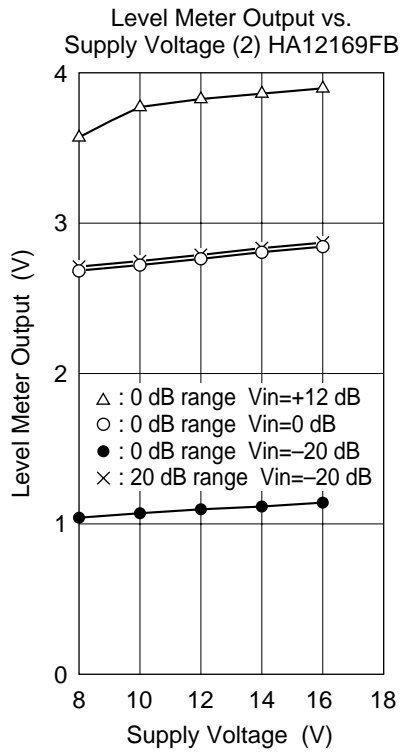



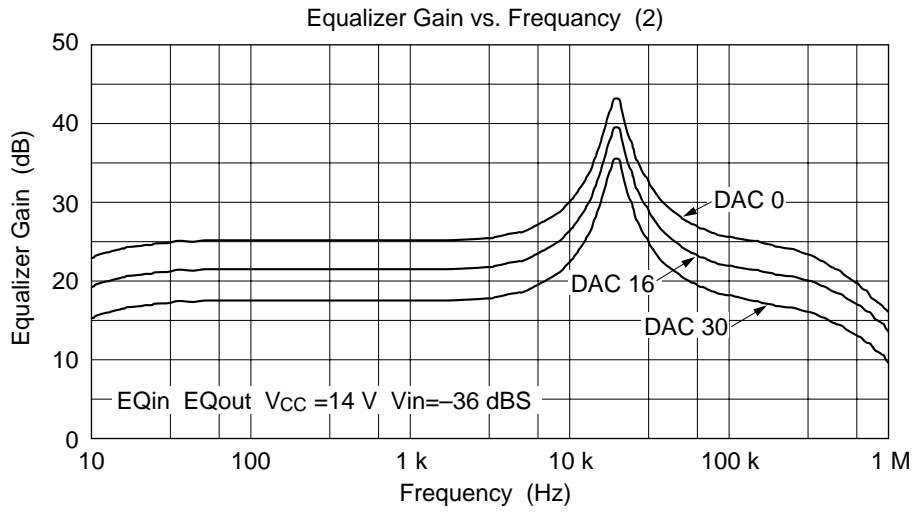
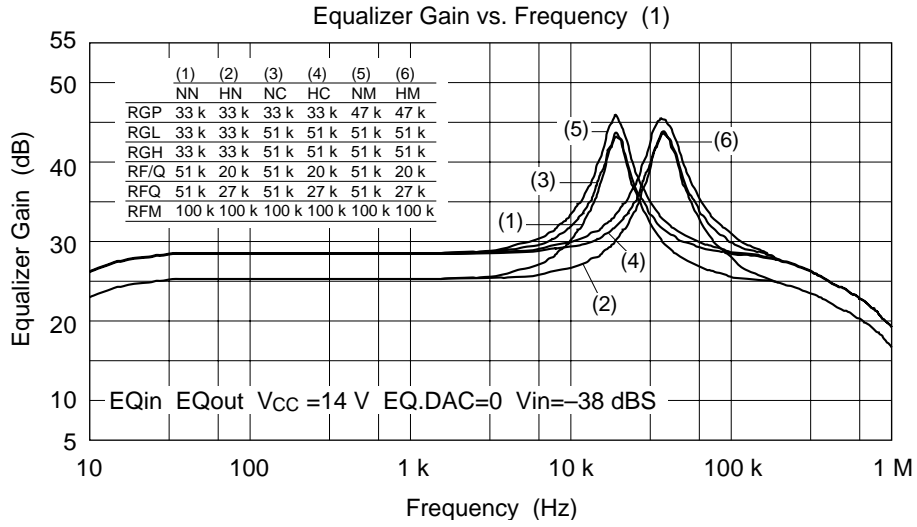

# HA12167FB/HA12169FB

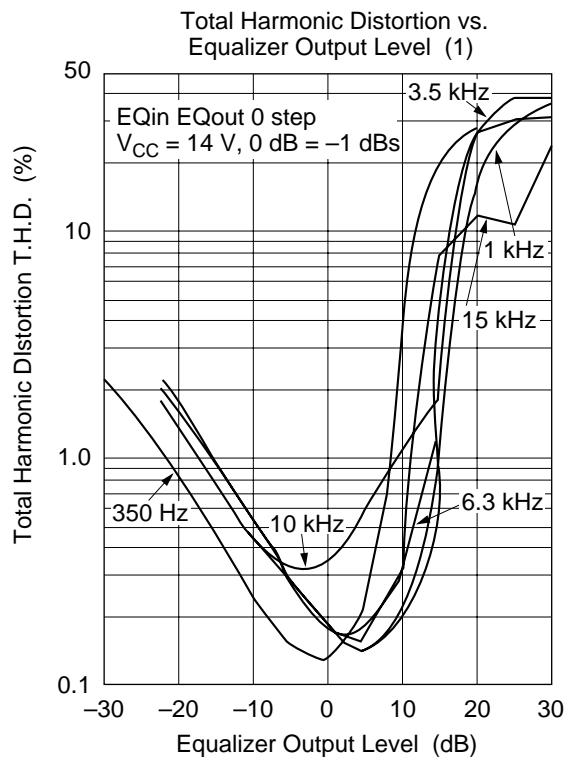
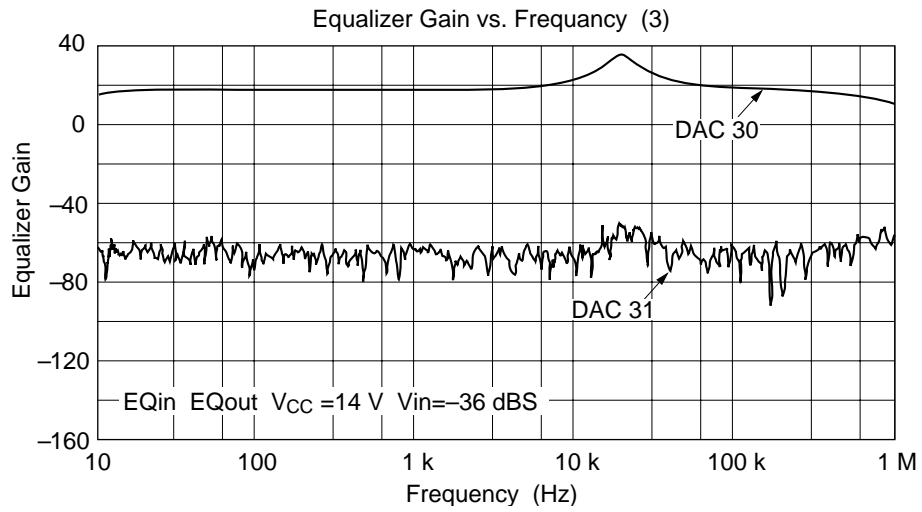

HITACHI

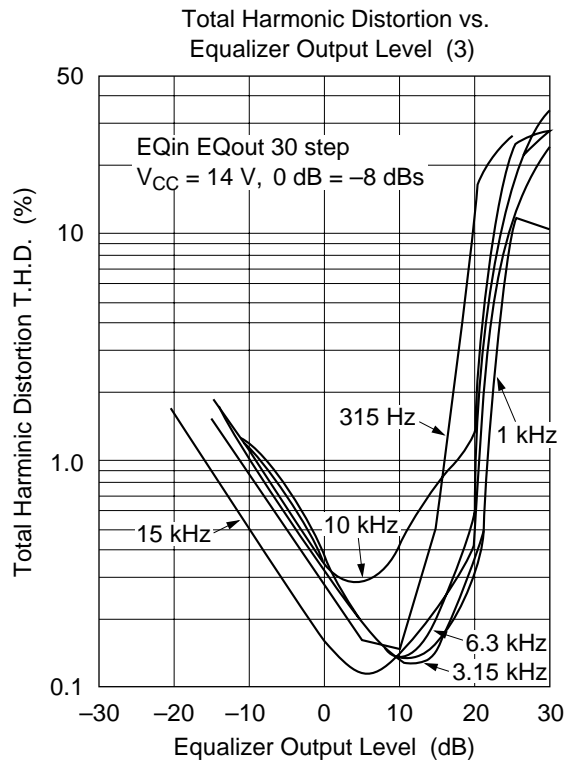
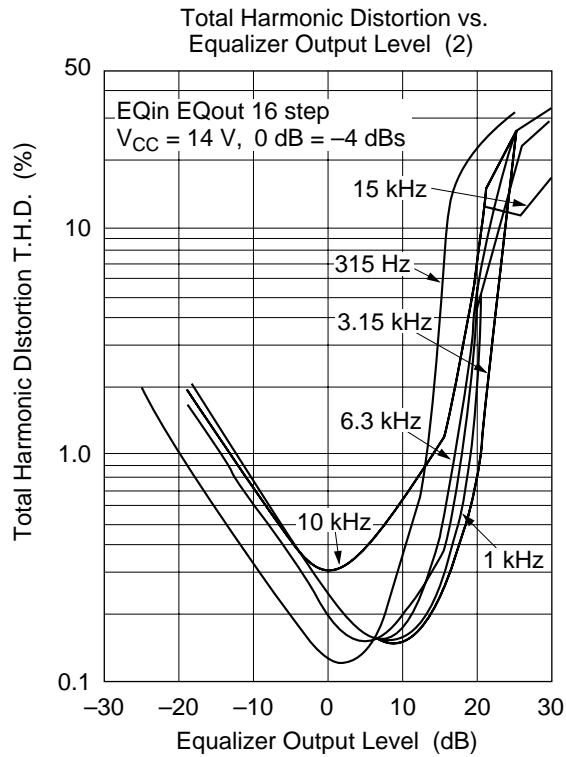

# HA12167FB/HA12169FB

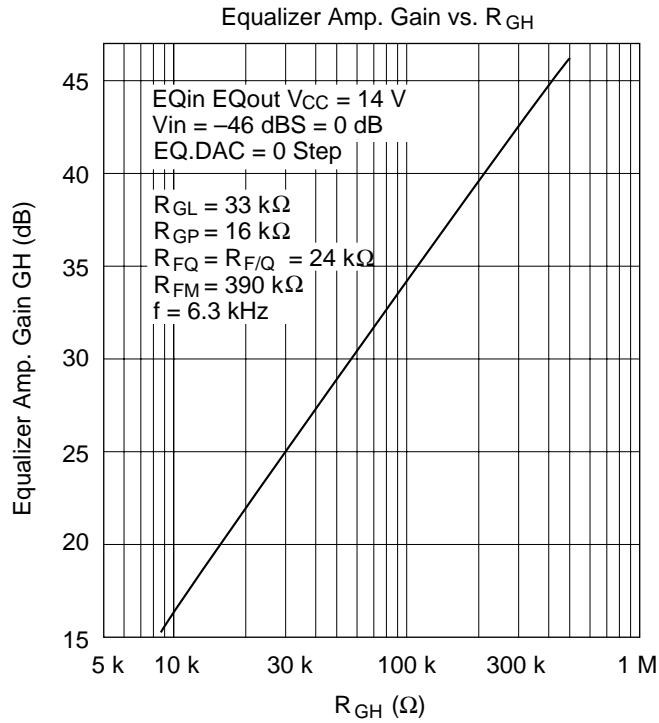
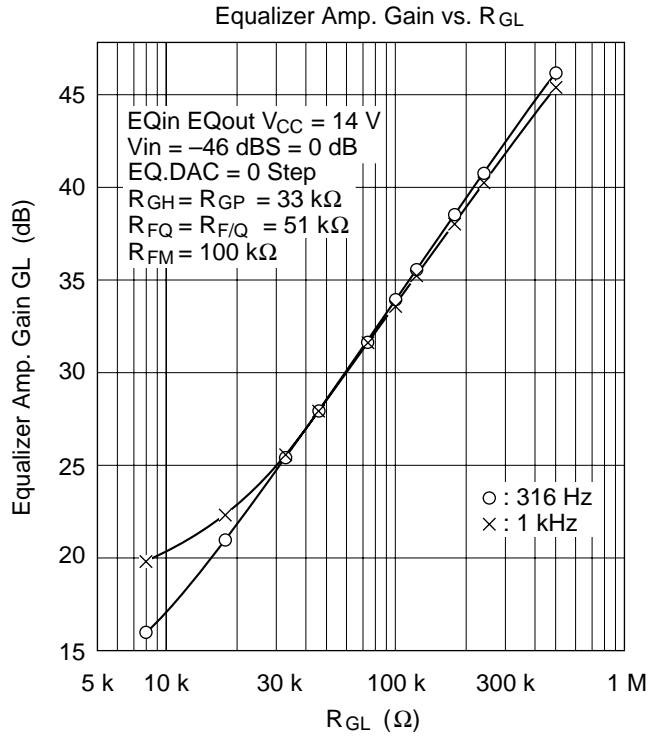

**HITACHI**

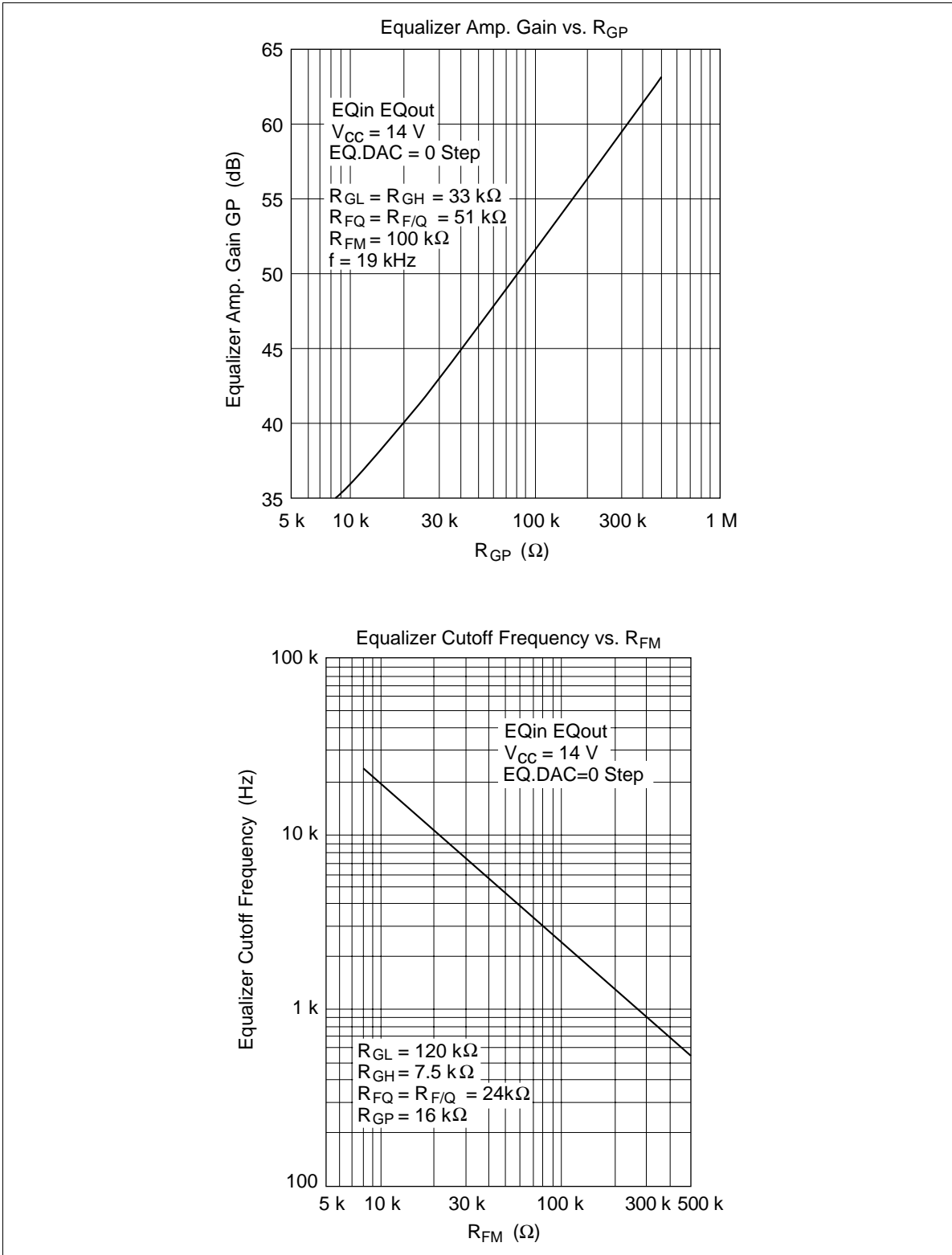

# HA12167FB/HA12169FB

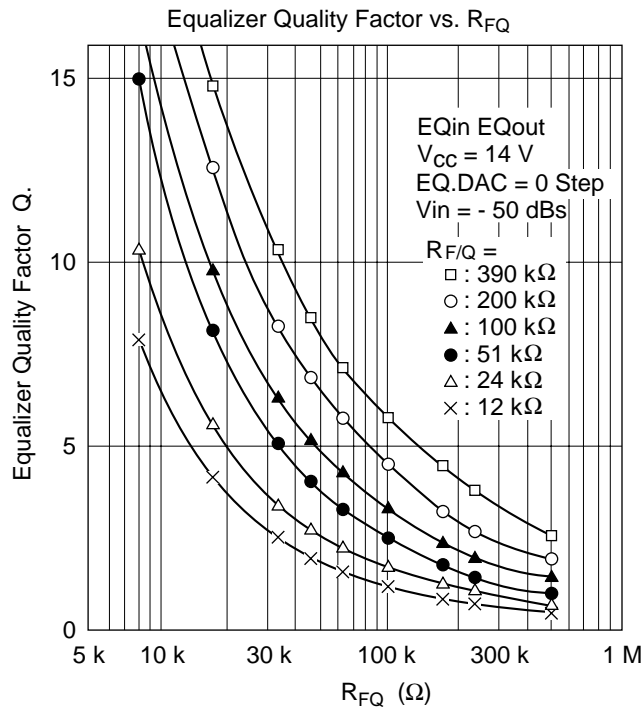
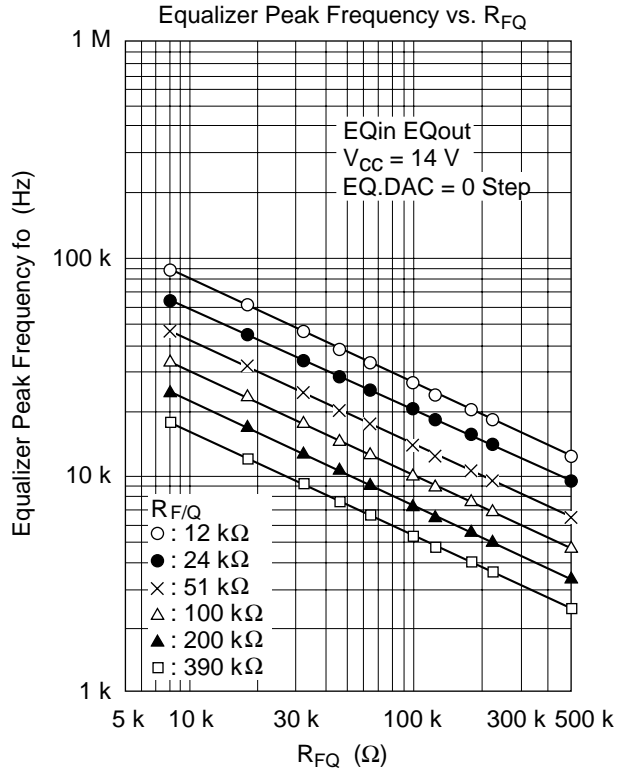

HITACHI

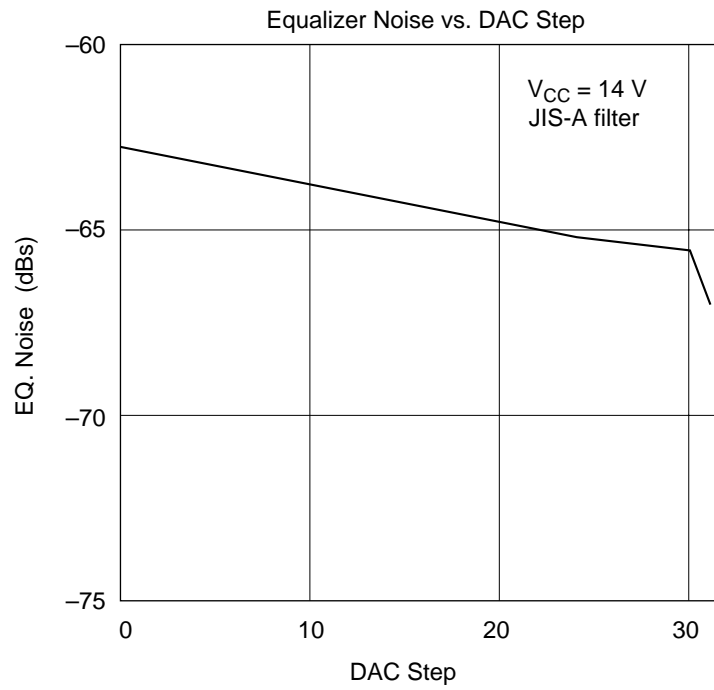
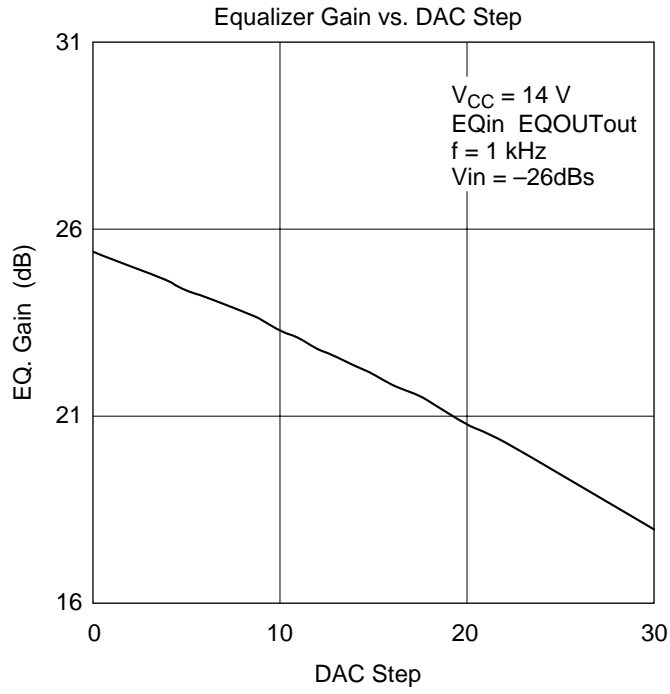

# HA12167FB/HA12169FB

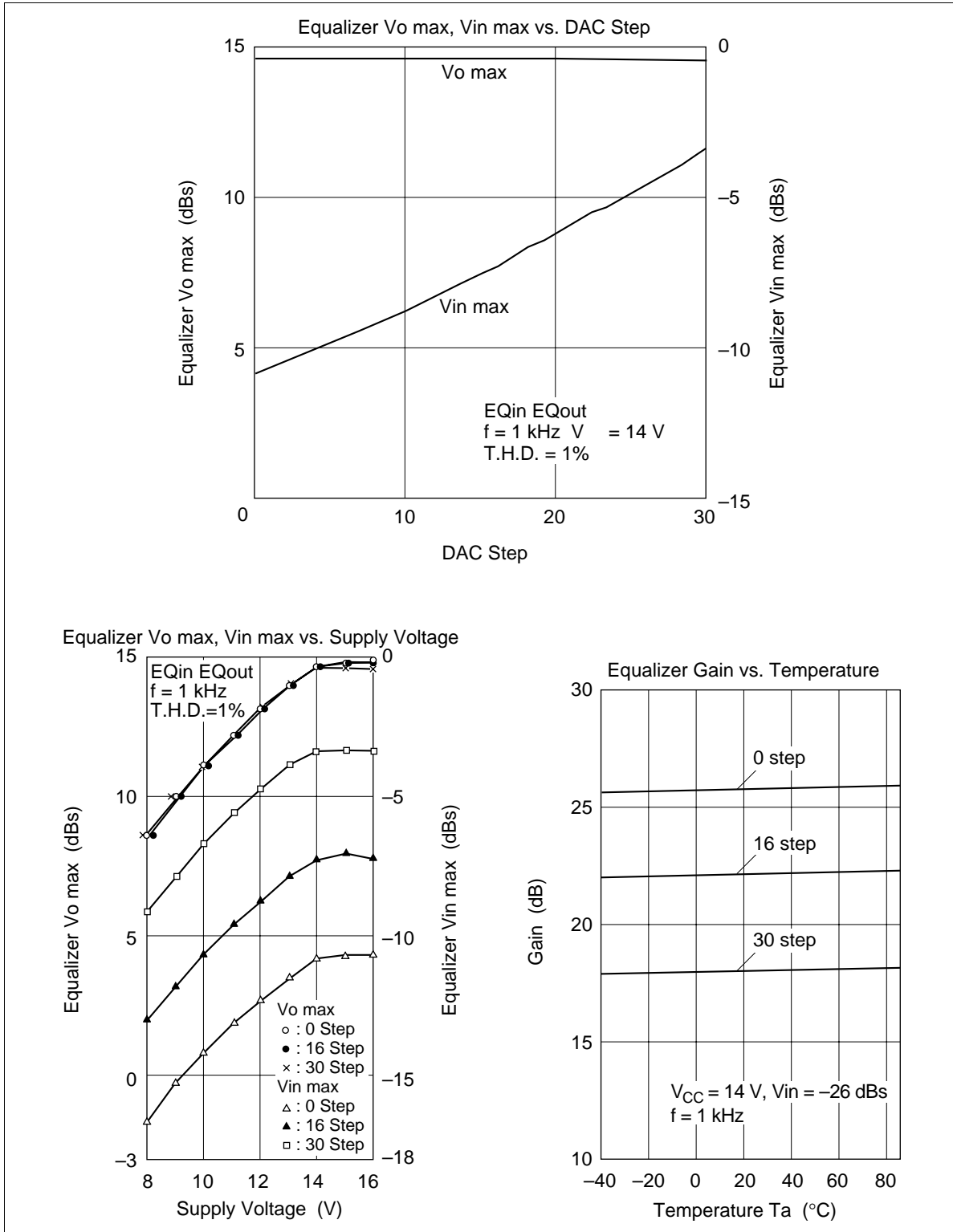



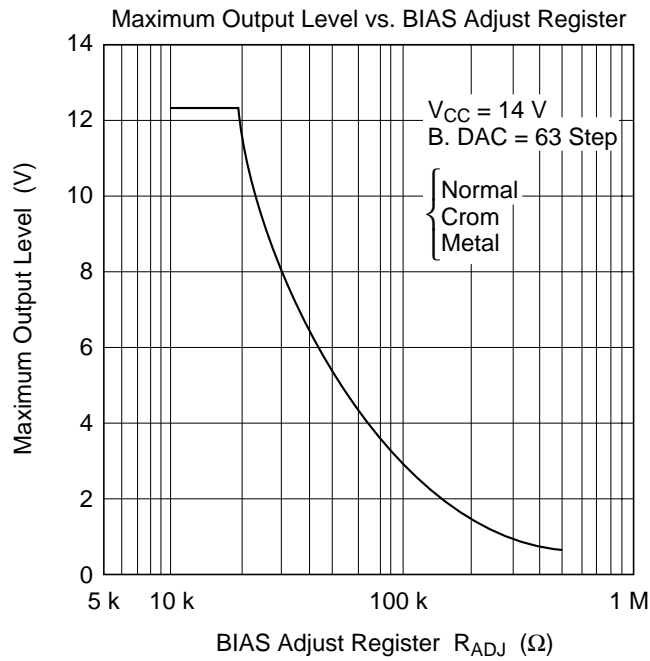
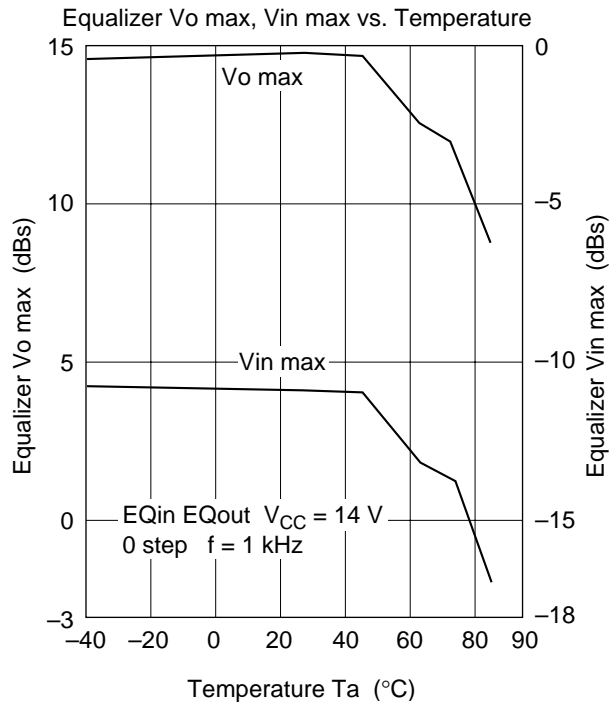

# HA12167FB/HA12169FB

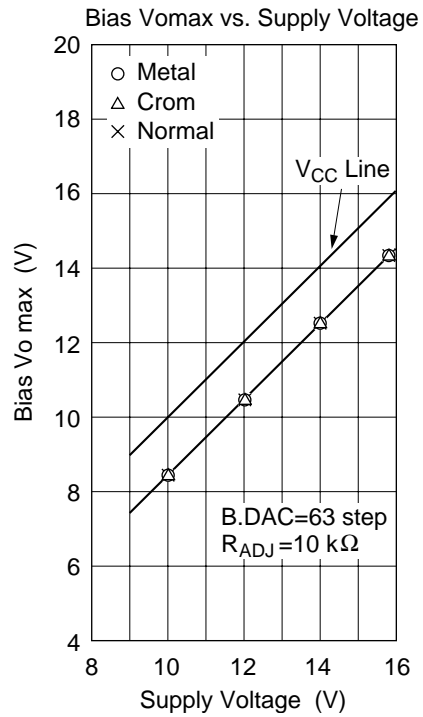
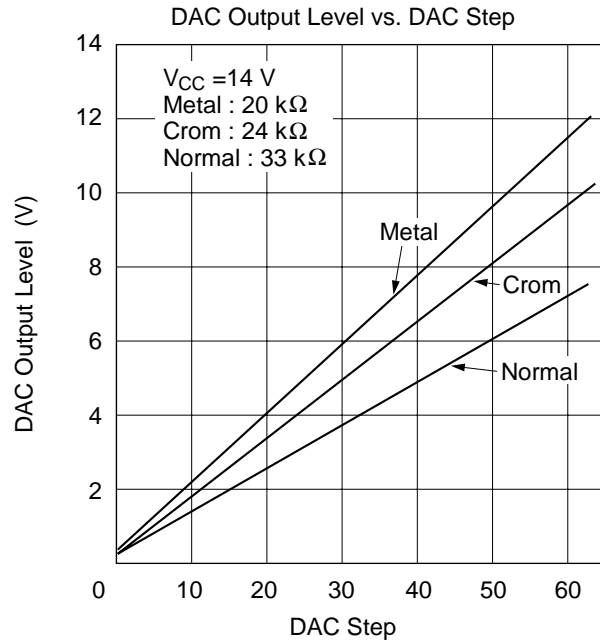

Package Dimensions

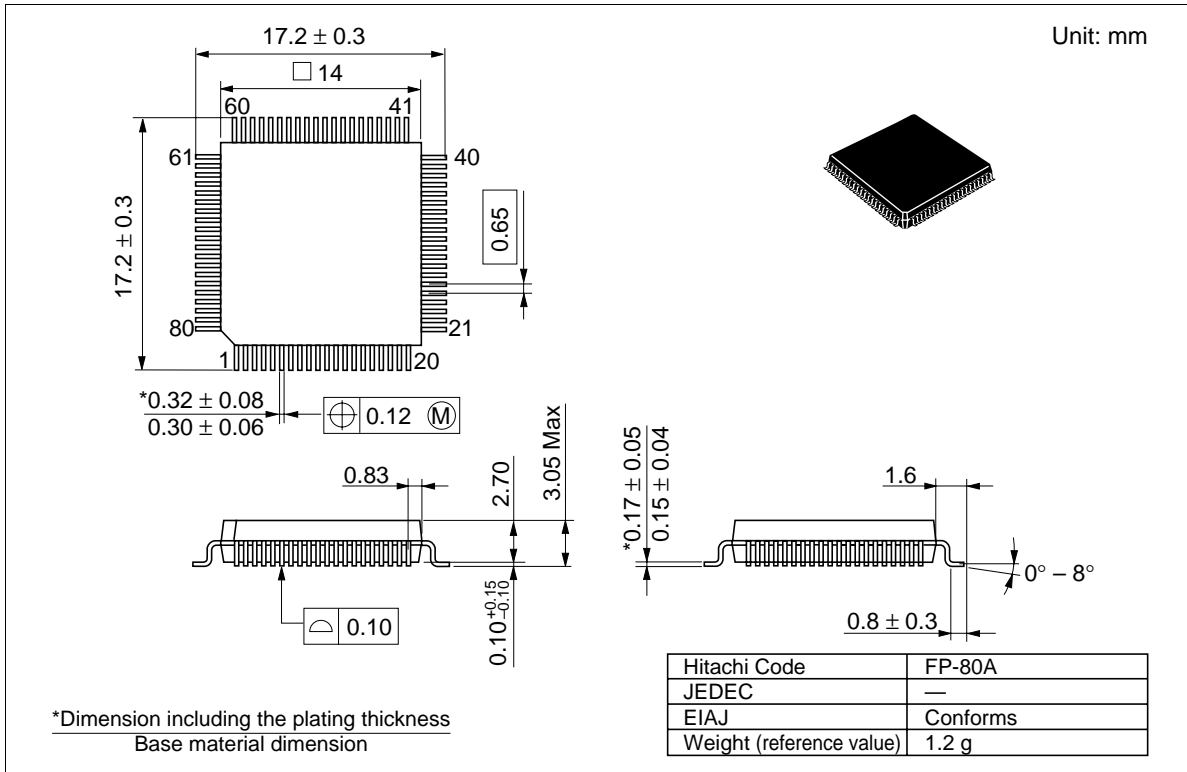

---

## HA12167FB/HA12169FB

---

### Cautions

1. Hitachi neither warrants nor grants licenses of any rights of Hitachi's or any third party's patent, copyright, trademark, or other intellectual property rights for information contained in this document. Hitachi bears no responsibility for problems that may arise with third party's rights, including intellectual property rights, in connection with use of the information contained in this document.
2. Products and product specifications may be subject to change without notice. Confirm that you have received the latest product standards or specifications before final design, purchase or use.
3. Hitachi makes every attempt to ensure that its products are of high quality and reliability. However, contact Hitachi's sales office before using the product in an application that demands especially high quality and reliability or where its failure or malfunction may directly threaten human life or cause risk of bodily injury, such as aerospace, aeronautics, nuclear power, combustion control, transportation, traffic, safety equipment or medical equipment for life support.
4. Design your application so that the product is used within the ranges guaranteed by Hitachi particularly for maximum rating, operating supply voltage range, heat radiation characteristics, installation conditions and other characteristics. Hitachi bears no responsibility for failure or damage when used beyond the guaranteed ranges. Even within the guaranteed ranges, consider normally foreseeable failure rates or failure modes in semiconductor devices and employ systemic measures such as fail-safes, so that the equipment incorporating Hitachi product does not cause bodily injury, fire or other consequential damage due to operation of the Hitachi product.
5. This product is not designed to be radiation resistant.
6. No one is permitted to reproduce or duplicate, in any form, the whole or part of this document without written approval from Hitachi.
7. Contact Hitachi's sales office for any questions regarding this document or Hitachi semiconductor products.

---

---

# HITACHI

## Hitachi, Ltd.

Semiconductor & Integrated Circuits.  
Nippon Bldg., 2-6-2, Ohte-machi, Chiyoda-ku, Tokyo 100-0004, Japan  
Tel: Tokyo (03) 3270-2111 Fax: (03) 3270-5109

URL      North America      : <http://semiconductor.hitachi.com/>  
             Europe                : <http://www.hitachi-eu.com/hel/ecg>  
             Asia (Singapore)      : <http://www.has.hitachi.com.sg/grp3/sicd/index.htm>  
             Asia (Taiwan)            : [http://www.hitachi.com.tw/E/Product/SICD\\_Frame.htm](http://www.hitachi.com.tw/E/Product/SICD_Frame.htm)  
             Asia (HongKong)        : <http://www.hitachi.com.hk/eng/bo/grp3/index.htm>  
             Japan                        : <http://www.hitachi.co.jp/Sicd/indx.htm>

### For further information write to:

Hitachi Semiconductor  
(America) Inc.  
179 East Tasman Drive,  
San Jose, CA 95134  
Tel: <1> (408) 433-1990  
Fax: <1> (408) 433-0223

Hitachi Europe GmbH  
Electronic components Group  
Dornacher Straße 3  
D-85622 Feldkirchen, Munich  
Germany  
Tel: <49> (89) 9 9180-0  
Fax: <49> (89) 9 29 30 00

Hitachi Europe Ltd.  
Electronic Components Group.  
Whitebrook Park  
Lower Cookham Road  
Maidenhead  
Berkshire SL6 8YA, United Kingdom  
Tel: <44> (1628) 585000  
Fax: <44> (1628) 778322

Hitachi Asia Pte. Ltd.  
16 Collyer Quay #20-00  
Hitachi Tower  
Singapore 049318  
Tel: 535-2100  
Fax: 535-1533

Hitachi Asia Ltd.  
Taipei Branch Office  
3F, Hung Kuo Building, No.167,  
Tun-Hwa North Road, Taipei (105)  
Tel: <886> (2) 2718-3666  
Fax: <886> (2) 2718-8180

Hitachi Asia (Hong Kong) Ltd.  
Group III (Electronic Components)  
7/F., North Tower, World Finance Centre,  
Harbour City, Canton Road, Tsim Sha Tsui,  
Kowloon, Hong Kong  
Tel: <852> (2) 735 9218  
Fax: <852> (2) 730 0281  
Telex: 40815 HITEC HX

Copyright ' Hitachi, Ltd., 1998. All rights reserved. Printed in Japan.

**HITACHI**

## IC BLOCK DIAGRAM/TERMINAL DESCRIPTION

### Q408: UPC1330HA REC/PB

#### BLOCK DIAGRAM

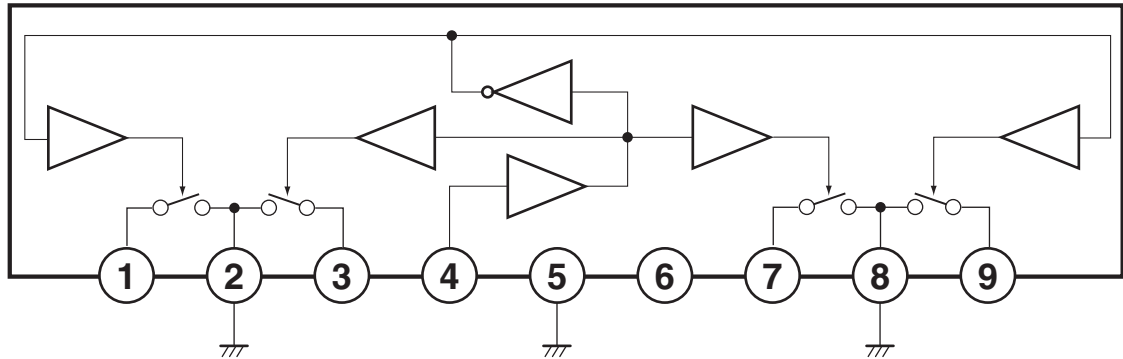

#### TERMINAL DESCRIPTION

PIN NO.	FUNCTION
1, 9	Playback signal
2	GND
3, 7	REC signal
4	REC/ PB switch control
5	GND
6	+B
8	GND

# MICROPROCESSOR BLOCK DIAGRAM/TERMINAL DESCRIPTION-1

## Q701 MPD78042FGF-141

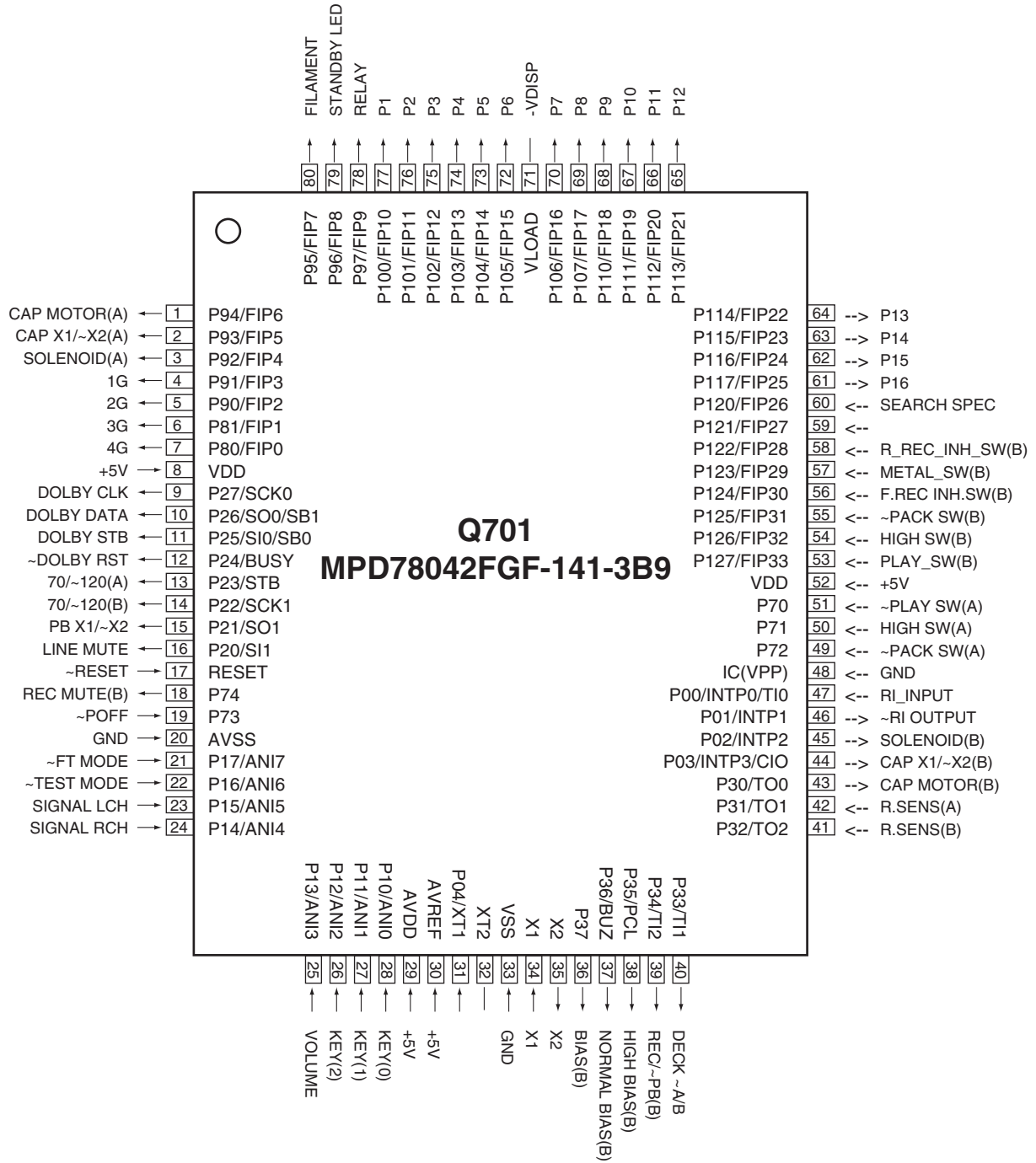

## MICROPROCESSOR BLOCK DIAGRAM/TERMINAL DESCRIPTION-2

## Q701 MPD78042FGF-141

NO.	PIN NAME	SIGN	I/O	DESCRIPTION
1	P94/FIP6	CAP MOTOR(A)	O	Capstan motor control output signal pin. (Deck-A)
2	P93/FIP5	CAP X1/~X2(A)	O	Capstan motor speed control output pin. (Deck-A)
3	P92/FIP4	SOLENOID(A)	O	Solenoid coil control signal output pin. (Deck-A)
4	P91/FIP3	1G	O	Grid (G1) control output pin.
5	P90/FIP2	2G	O	Grid (G2) control output pin.
6	P81/FIP1	3G	O	Grid (G3) control output pin.
7	P80/FIP0	4G	O	Grid (G4) control output pin.
8	VDD	+5V	I	+5 V. Power supply pin.
9	P27/SCK0	DOLBY CLK	O	Clock control output pin of dolby IC.
10	P26/SO0/SB1	DOLBY DATA	O	Data control output pin of dolby IC.
11	P25/SI0/SB0	DOLBY STB	O	Strobe control output pin of dolby IC.
12	P24/BUSY	~DOLBY RST	O	Reset control output pin of dolby IC.
13	P23/STB	70/~120(A)	O	Play equalizer signal select output pin. (Deck-A)
14	P22/SCK1	70/~120(B)	O	Play equalizer signal select output pin. (Deck-B)
15	P21/SO1	PB X1/~X2	O	Playback frequency bandwidth select signal output pin.
16	P20/SI1	LINE MUTE	O	Line mute signal control output pin.
17	RESET	~RESET	I	Reset signal input pin.
18	P74	REC MUTE(B)	O	Recording mute signal control output pin. (Deck-B)
19	P73	~POFF	I	power stoppage detection input pin.
20	AVSS	GND	I	GND. For A/D port of power supply.
21	P17/ANI7	~FT MODE	I	Test mode setting input pin. For factory.
22	P16/ANI6	~TEST MODE	I	Mechanism test mode input pin.
23	P15/ANI5	SIGNAL LCH	I	Display the level of L-channel/ search signal of A/D input pin.
24	P14/ANI4	SIGNAL RCH	I	Display the level of R-channel/ search signal of A/D input pin.
25	P13/ANI3	VOLUME	I	VOLUME A/D input pin.
26	P12/ANI2	KEY(2)	I	Key A/D input pin.
27	P11/ANI1	KEY(1)	I	Key A/D input pin.
28	P10/ANI0	KEY(0)	I	Key A/D input pin.
29	AVDD	+5V	I	5V. Power supply.
30	AVREF	+5V	I	Power supply pin for A/D port.
31	P04/XT1		I	Not used. To connect to GND.
32	XT2			Not used. Open pin.
33	VSS	GND	I	GND pin.
34	X1	X1	I	Clock signal input pin. (5MHz)
35	X2	X2	O	Clock signal output pin.
36	P37	BIAS(B)	O	Bias control output signal pin. (Deck-B)
37	P36/BUZ	NORMAL BIAS(B)	O	Bias (Normal) control output signal pin. (Deck-B)
38	P35/PCL	HIGH BIAS(B)	O	Bias (High) control output signal pin. (Deck-B)
39	P34/TI2	REC/~PB(B)	O	R/P head select output signal pin. (Deck-B)
40	P33/TI1	DECK ~A/B	O	R/P head select output signal pin. (Deck-A/B)
41	P32/TO2	R.SENS(B)	I	Detect the reel rotation input signal pin. (Deck-B)
42	P31/TO1	R.SENS(A)	I	Detect the reel rotation input signal pin. (Deck-A)
43	P30/TO0	CAP MOTOR(B)	O	Capstan motor control signal output pin. (Deck-B)
44	P03/INTP3/C	CAP X1/~X2(B)	O	Speed control of capstan motor output pin.
45	P02/INTP2	SOLENOID(B)	O	Solenoid control output pin. (Deck-B)
46	P01/INTP1	~RI OUTPUT	O	RI signal output pin.
47	P00/INTP0/T	RI_INPUT	I	RI signal input pin.
48	IC(VPP)	GND	I	GND. Internal connection pin.
49	P72	~PACK SW(A)	I	Tape installation detection input signal pin. (Deck-A.)
50	P71	HIGH SW(A)	I	Tape class (HIGH) detection signal input terminal. (Deck-A)

## MICROPROCESSOR BLOCK DIAGRAM/TERMINAL DESCRIPTION-3

## Q701 MPD78042FGF-141

NO.	PIN NAME	SIGN	I/O	DESCRIPTION
51	P70	~PLAY SW(A)	I	Head position detection input signal pin. (Deck-A)
52	VDD	+5V	I	+5V.
53	P127/FIP33	PLAY_SW(B)	I	Head position detection input signal pin. (Deck-B)
54	P126/FIP32	HIGH SW(B)	I	Tape class (HIGH) detection signal input pin. (Deck-B)
55	P125/FIP31	~PACK SW(B)	I	Tape installation detection signal input pin. (Deck-B)
56	P124/FIP30	F.REC INH.SW(B)	I	Prohibition setting detection signal switch input pin of FWD recording. (Deck-B)
57	P123/FIP29	METAL_SW(B)	I	Tape class (METAL) detection signal input pin. (Deck-B)
58	P122/FIP28	R_REC_INH_SW(B)	I	Prohibition setting detection signal switch input pin of FWD recording. (Deck-B)
59	P121/FIP27		I	Not used.
60	P120/FIP26	SEARCH SPEC	I	Input terminal for setting whether to install selection.
61	P117/FIP25	P16	O	Segment (P16) control output pin.
62	P116/FIP24	P15	O	Segment (P15) control output pin.
63	P115/FIP23	P14	O	Segment (P14) control output pin.
64	P114/FIP22	P13	O	Segment (P13) control output pin.
65	P113/FIP21	P12	O	Segment (P12) control output pin.
66	P112/FIP20	P11	O	Segment (P11) control output pin.
67	P111/FIP19	P10	O	Segment (P10) control output pin.
68	P110/FIP18	P9	O	Segment (P9) control output pin.
69	P107/FIP17	P8	O	Segment (P8) control output pin.
70	P106/FIP16	P7	O	Segment (P7) control output pin.
71	VLOAD	-VDISP		Negative power supply for FL tube.
72	P105/FIP15	P6	O	Segment (P6) control output pin.
73	P104/FIP14	P5	O	Segment (P5) control output pin.
74	P103/FIP13	P4	O	Segment (P4) control output pin.
75	P102/FIP12	P3	O	Segment (P3) control output pin.
76	P101/FIP11	P2	O	Segment (P2) control output pin.
77	P100/FIP10	P1	O	Segment (P1) control output pin.
78	P97/FIP9	RELAY	O	Relay control output signal pin.
79	P96/FIP8	STANDBY LED	O	Standby LED control output pin.
80	P95/FIP7	FILAMENT	O	Filament control signal output pin.

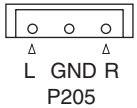

# ADJUSTMENT PROCEDURE

Item	Connection of instrument	Line output	Test tape	Mode	Output Indicator	Adjustment point	Adjust	Remark
1	Tape speed Frequency counter to LINE output terminal		MTT-111N or TCC-111	PB	Frequency counter	DECK: R802 (H.S.) A R803 (N.S.) DECK: R817 (H.S.) B R818 (N.S.)	High speed 6000-6020Hz Normal speed 3000-3010Hz	High speed first. Refer to item FT MODE
2	Head azimuth AC voltmeter and oscilloscope to LINE output terminal		TCC-153 or MTT-114N	PB	AC voltmeter	Head azimuth screw FWD: right REV: left	Maximum and same phase at channels Lch and Rch	
3	Playback level AC voltmeter to terminals P205 (See to remarks)		MTT-150 or TCC-130	PB	AC voltmeter	DECK: R117 (Lch) A R118 (Rch) DECK: R119 (Lch) B R120 (Rch)	300mV	 L GND R P205
4	OSC block Frequency counter to P102, read loose coupling		METAL tape	REC	Frequency counter	L403	85KHz±1KHz	
5	Bias current	1KHz, -23dB and 12KHz, -23dB	Normal tape	REC/PB	AC voltmeter	R403 (Lch) R404 (Rch)	-0.5 to +1.0dB at 1KHz and 12KHz	
6	Record level	1KHz 350mV	Normal tape	REC/PB	AC voltmeter	R225 (Lch) R226 (Rch)	same level at REC/PB	

**FT MODE**

Test mode will be alive when P705 FT connect to GND.

When pressed the PLAY key in the same direction as that for replay while replaying, the tape speed will be increase to high speed. And if pressed the same key while running at high speed, the speed will be set back to normal one.

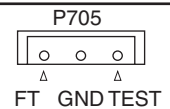

**Standard Tape** NORM:UD-1 HIGH:UD-2 METAL:TCC403A

## PC BOARD LAYOUT NAAF-8555

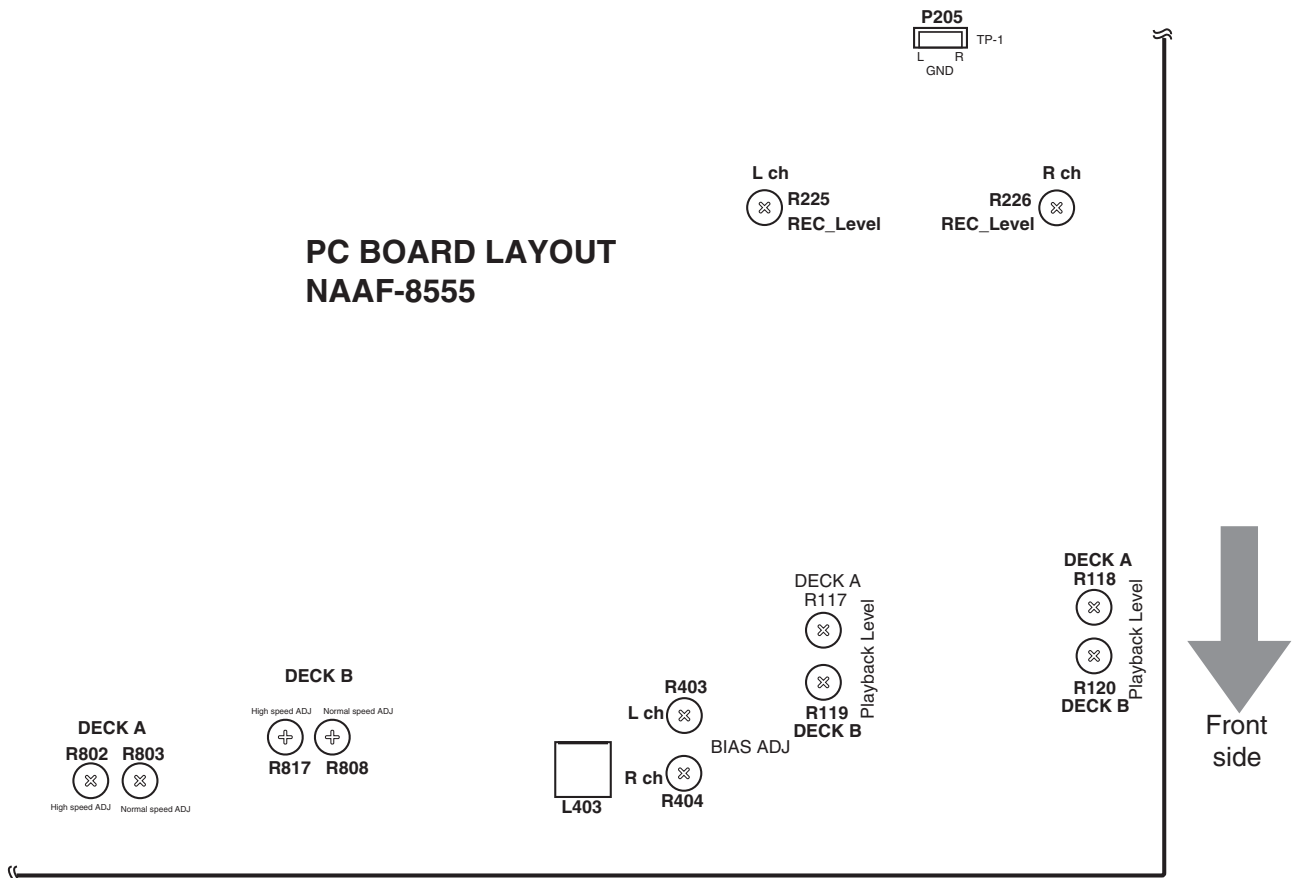

PACKING VIEW

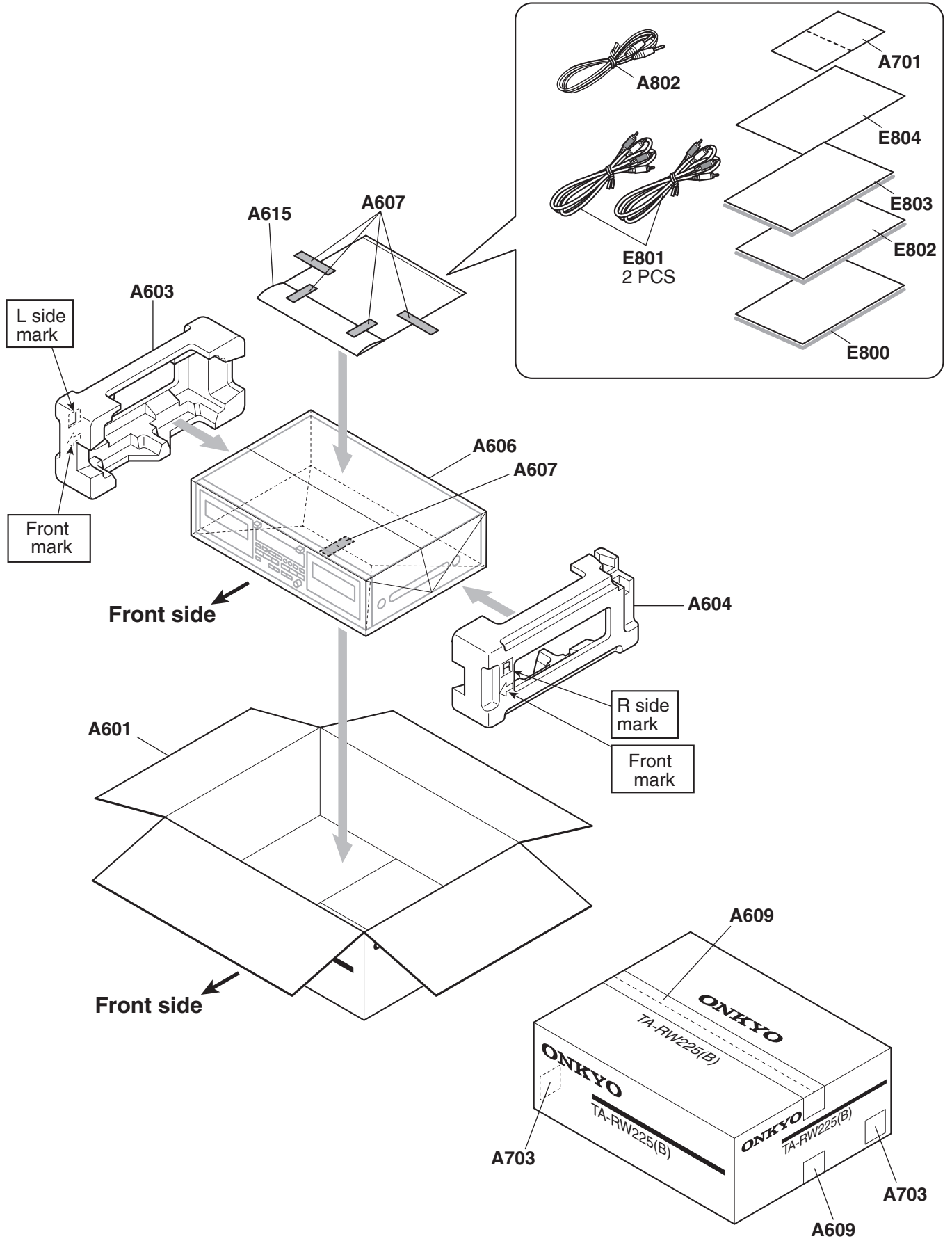

**PARTS LIST**  
**EXPLODED VIEW PARTS LIST**

**TA-RW255**

REF. NO.	PART NAME	DESCRIPTION	PART NO.	REMARK
A001	F BRACKET	AS	1 27110984-1A	N <B>
A001	F BRACKET	AS	1 27111411	N <S>
A003	SCREW	3TTF+6B(BC)	4 835430068	
A004	SCREW	3TTB+8B(BC)	2 838430088	
A006	CLEAR PLT	(B)	1 28192071	N <B>
A006	CLEAR PLT	(S)	1 28192072	N <S>
A007	DAMPER	FRT-PN4	2 24611627	
A008	KNOB	(EJ)	2 28324943	N <B>
A008	KNOB	(EJ)	2 28326336	N <S>
A010	BRACKET	BRACKET	2 27130729B	
A011	SCREW	3TTB+8B(BC)	4 838430088	
A013	CST FRM	CST FRM	2 27301792B	
A014	SPRING	OSAE-BANE	4 27180272A	
A015	SPRING	OSIBANE(A)	1 27180477A	
A016	SPRING	OSIBANE(B)	1 27180476A	
A017	CHASSIS	CHASSIS	1 27100322A	
A018	SCREW	3TTB+8B(BC)	4 838430088	
A019	HOLDER	PCB-8L	2 27190480-1	
A020	BRACKET	(PC)	1 27130747	
A021	KNOB	KNOB-VOL	1 28323671A	
A021	KNOB	(VOL)	1 28326337	N
A026	BUSHING	S-RELIEF #2271	1 27300750	!
A028	SCREW	4TTC+8C(BC)	4 830440089	
A029	SCREW	3TTB+8B(BC)	13 838430088	
A030	TAPE	TAPE(CLOTH-8U)	1 29110082	
A201	REAR PANEL	MDD	1 27123450	N <B MDD>
A201	REAR PANEL	MPP,MPA	1 27123451	N <B MPP>
A201	REAR PANEL	MPP,MPA	1 27123451	N <B MPA>
A201	REAR PANEL	MGT	1 27123452	N <B MGT>
A201	REAR PANEL	MPP,MPA	1 27123451	N <S MPP>
A202	SCREW	3TTB+8B(BC)	7 838430088	
A203	KNOB	(POW)	1 28325489	Except <B MDD>
A203	KNOB	(POW)	1 28326335	N <S MPP>
A204	RETAINER	(POW)	1 27141674	Except <B MDD>
A205	SCREW	3TTB+10S(BC)	2 838430107	Except <B MDD>
A206	SCREW	3TTB+8B(BC)	2 838430088	<MPA, MPP>
A206	SCREW	3TTB+8B	2 838130088	<MGT>
A208	LABEL	(WEEE)	1 29364199	<MPP>
A301	COVER	--	1 28184664-1	<B>
A301	COVER	--	1 28184933	N <S>
A302	SCREW	3TTB+8B(BC)	6 838430088	<B>
A302	SCREW	3TTB+8B(UN)	6 838930088	<S>
A305	F PANEL	(B)MDD	1 27212787	N <B MDD>
A305	F PANEL	(B)MPP	1 27212785	N <B MPP>
A305	F PANEL	(B)MPP	1 27212785	N <B MPA>
A305	F PANEL	(B)MPP	1 27212785	N <B MGT>
A305	F PANEL	(S)MPP	1 27212786	N <S MPP>
A306	SCREW	3TTB+8B(BC)	3 838430088	
A307	FACET	(POW)	1 28198859	
A308	BADGE	BADGE	1 28135244	<B>
A308	BADGE	.	1 28135298	<S>
A311	LEG	LEG	4 27175316C	
A312	SCREW	3TTB+8B(BC)	4 838430088	LEG
A313	CUSHION	.	8 28141494	
A315	CST LID	CST LID(A)	1 27301853	<B>
A315	CST LID	(A)	1 27301955	N <S>
A316	CST LID	CST LID(B)	1 27301853-1	<B>
A316	CST LID	(B)	1 27301956	N <S>
A317	WINDOW	(B)	2 27301953	N <B>
A317	WINDOW	(S)	2 27301954	N <S>
E851	CLAMP	WS-2NS	1 27300833-2	
E862	CLAMP	HL-38-0	1 27301779	Except <MDD>
P101	SOCKET AS	NSAS-6P0446	1 2009990312	
P102	SOCKET AS	NSAS-14P0447	1 2009990313	

P701	FFC	NCFC7-292512	1	2047292512	
P801	FFC	NCFC7-102512	1	2047102512	
P802	FFC	NCFC7-131512	1	2047131512	N
P901A	AC CORD	AS-UC-2	1	253368LTK	! <MDD>
P901A	AC CORD	AS-CEE	1	253336VOL	! <MPP>
P901A or	AC CORD	AS-CEE	( 1)	253335HIT	! <MPP>
P901A	AC CORD	AS-SAA	1	253388HIT	! <MPA>
P901A	AC CORD	AS-CEE	1	253336VOL	! <MGT>
P901A or	AC CORD	AS-CEE	( 1)	253335HIT	! <MGT>
T901	P TRANS	NPT-1523D	1	2301821	N ! <MDD>
T901	P TRANS	NPT-1523P	1	2301822	N ! <MPP>
T901	P TRANS	NPT-1523P	1	2301822	N ! <MPA>
T901	P TRANS	NPT-1523G	1	2301823	N ! <MGT>
U01	MAIN PC BOARD ASSY	NAAF-8555-1A	1	1N286555-1A	N <MDD>
U01	MAIN PC BOARD ASSY	NAAF-8555-1B	1	1N286555-1B	N <MPP>
U01	MAIN PC BOARD ASSY	NAAF-8555-1C	1	1N286555-1C	N <MPA>
U01	MAIN PC BOARD ASSY	NAAF-8555-1D	1	1N286555-1D	N <MGT>
U02	DISPLAY CIRCUIT PC BOARD ASSY	MADIS-8556-1A	1	1N286556-1A	N <MDD>
U02	DISPLAY CIRCUIT PC BOARD ASSY	MADIS-8556-1B	1	1N286556-1B	N <MPP>
U02	DISPLAY CIRCUIT PC BOARD ASSY	MADIS-8556-1C	1	1N286556-1C	N <MPA>
U02	DISPLAY CIRCUIT PC BOARD ASSY	MADIS-8556-1D	1	1N286556-1D	N <MGT>
U03	POWER SUPPLY PC BOARD ASSY	NAPS-8557-1A	1	1N286557-1A	N <MDD>
U03	POWER SUPPLY PC BOARD ASSY	NAPS-8557-1B	1	1N286557-1B	N <MPP>
U03	POWER SUPPLY PC BOARD ASSY	NAPS-8557-1C	1	1N286557-1C	N <MPA>
U03	POWER SUPPLY PC BOARD ASSY	NAPS-8557-1D	1	1N286557-1D	N <MGT>
U04	INPUT VOLUME PC BOARD ASSY	NAETC-8558-1A	1	1N286558-1A	N <MDD>
U04	INPUT VOLUME PC BOARD ASSY	NAETC-8558-1B	1	1N286558-1B	N <MPP>
U04	INPUT VOLUME PC BOARD ASSY	NAETC-8558-1C	1	1N286558-1C	N <MPA>
U04	INPUT VOLUME PC BOARD ASSY	NAETC-8558-1D	1	1N286558-1D	N <MGT>
U05	POWER SWITCH PC BOARD ASSY	NASW-8559-1B	1	1N286559-1B	N <MPP>
U05	POWER SWITCH PC BOARD ASSY	NASW-8559-1C	1	1N286559-1C	N <MPA>
U05	POWER SWITCH PC BOARD ASSY	NASW-8559-1D	1	1N286559-1D	N <MGT>
Z001	DECK MECHA	CMAL2Z226B	1	244249A	N
Z002	DECK MECHA	CMAL2Z227B	1	244250A	N
Z003	LEVER	LEVER(EJ)L TARW222	1	24603402A	
Z004	LEVER	LEVER(EJ)R TARW222	1	24603404A	
Z005	RETAINER	RETAINER L AS W222	1	24611591A	
Z006	RETAINER	RETAINER R AS W222	1	24611593A	
Z007	SPRING	SPRING	2	24605798	
Z008	E-WASHER	ES-3S	2	8930301S	
Z008 or	E-WASHER	RING (E) KW511M	( 2)	8930301	
Z009	SCREW	2.6TTP+4S	4	833126047	

<MDD>: North American mode      <B>: Black color model  
 <MPP>: Europe model                <S>: Silver color model  
 <MPA>: Australian mode            ! : Safety parts  
 <MGT>: Asian mode!

**PACKING PARTS LIST**

**TA-RW255**

REF. NO.	PART NAME	DESCRIPTION	PART NO.	REMARK
A601	CARTON	(B)	1 29054368A	N <B>
A601	CARTON	(S)	1 29054369A	N <S>
A603	PAD	(L)	1 29091636-1D	
A604	PAD	(R)	1 29091637-1D	
A606	POLY BAG	POLY BAG(850*650)	1 29100034-1A	
A607	TAPE	(SEROHAN)NITTO NO.29	1 29110149	
A609	PP TAPE	W48 OPP TAPE	1 29110148	
A615	POLY BAG	350*250	1 29100097-1A	
A701	WRNTY CARD	(ONKYO)	1 29365090C	N <MDD>
A703	UPC LABEL	TA-RW255(B)	1 29364155	N <B MDD>
A703	EAN LABEL	TA-RW255(B)	1 29364153	N <B MPP>
A703	EAN LABEL	TA-RW255(S)	1 29364154	N <B MPA><BMGT>
A703	EAN LABEL	TA-RW255(S)	1 29364154	N <S MPP>
A801	CORD AS	PIN CORD AS	2 2010326	
A801 or	PIN CORD	PIN CORD AS	( 2) 2010244	
A802	PLUG CORD	3.5-MINI PLUG (RI)	1 2010200	
E800	INS MANUAL	En(TARW255)	1 29343966	
E802	INS MANUAL	U3FrEsIt(TARW255)	1 29343967	N <MPP>
E802	INS MANUAL	Ct(TARW255)	1 29344020	N <MGT>
E803	INS MANUAL	U3DeNISv(TARW255)	1 29343968	N <MPP>
E804	INST SHEET	U7(EN60065)	1 29355447	N <MPP>

---

**ONKYO CORPORATION**

Sales & Product Planning Div. : 2-1, Nisshin-cho, Neyagawa-shi, OSAKA 572-8540, JAPAN  
Tel: 072-831-8023 Fax: 072-831-8124

**ONKYO U.S.A. CORPORATION**

18 Park Way, Upper Saddle River, N.J. 07458, U.S.A.  
Tel: 201-785-2600 Fax: 201-785-2650 <http://www.us.onkyo.com/>

**ONKYO EUROPE ELECTRONICS GmbH**

Liegnitzerstrasse 6, 82194 Groebenzell, GERMANY  
Tel: +49-8142-4401-0 Fax: +49-8142-4401-555 <http://www.eu.onkyo.com/>

**ONKYO EUROPE UK Office**

Suite 1, Gregories Court, Gregories Road, Beaconsfield, Buckinghamshire, HP9 1HQ  
UNITED KINGDOM Tel: +44-(0)1494-681515 Fax: +44(0)-1494-680452

**ONKYO CHINA LIMITED**

Units 2102-2107, Metroplaza Tower I, 223 Hing Fong Road, Kwai Chung,  
N.T., HONG KONG Tel: 852-2429-3118 Fax: 852-2428-9039  
<http://www.ch.onkyo.com/>

